

### Features

- Built using the advantages and compatibility of CMOS and IXYS HDMOS™ processes
- Latch-Up Protected Over Entire Operating Range
- High Peak Output Current: 14A Peak
- Wide Operating Range: 4.5V to 35V
- -55 °C to 125 °C Extended Operating Temperature Standard
- High Capacitive Load Drive Capability: 15nF in <30ns
- Matched Rise And Fall Times
- Low Propagation Delay Time
- Low Output Impedance
- Low Supply Current

### Applications

- Driving MOSFETs and IGBTs
- Motor Controls
- Line Drivers
- Pulse Generators
- Local Power ON/OFF Switch
- Switch Mode Power Supplies (SMPS)
- DC to DC Converters

### General Description

The IXDI414/IXDN414 are high speed high current gate drivers specifically designed to drive the largest MOSFETs and IGBTs to their minimum switching time and maximum practical frequency limits. The IXDI/N414 can source and sink 14A of peak current, while producing voltage rise and fall times of less than 30ns, to drive the latest IXYS MOSFETs & IGBTs. The input of the driver is compatible with TTL or CMOS and is fully immune to latch up over the entire operating range. Designed with small internal delays, a patent-pending circuit virtually eliminates transistor cross conduction and current shoot-through. Improved speed and drive capabilities are further enhanced by very low, matched rise and fall times.

The IXDN414 is configured as a non-inverting gate driver and the IXDI414 is an inverting gate driver.

The IXDN414/IXDI414 family are available in standard 8 pin P-DIP (PI), 5-pin TO-220 (CI), TO-263 (YI) and thermally enhanced 14-pin SOIC (SI) surface-mount packages.

Figure 1 - IXDN414 14A Non-Inverting Gate Driver Functional Block Diagram

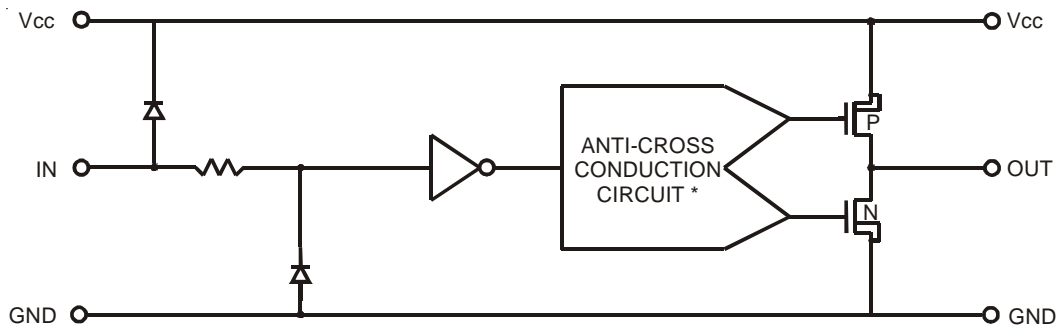

\* Patent Pending

Figure 2 - IXDI414 Inverting 14A Gate Driver Functional Block Diagram

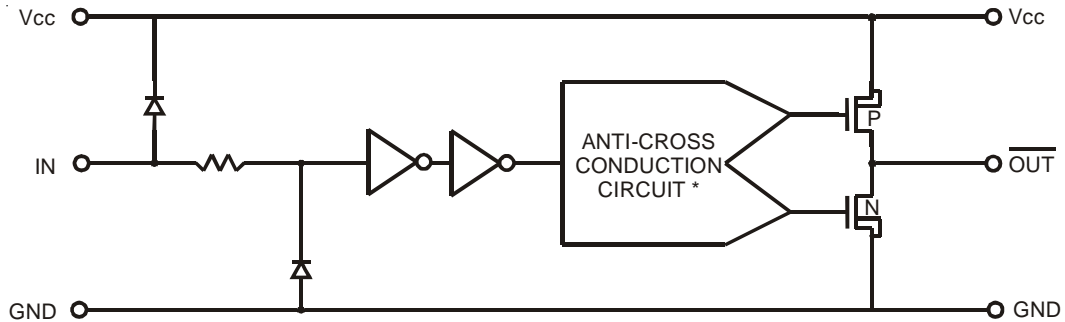

**Pin Description And Configuration**

SYMBOL	FUNCTION	DESCRIPTION
VCC	Supply Voltage	Positive power-supply voltage input. This pin provides power to the entire chip. The range for this voltage is from 4.5V to 35V.
IN	Input	Input signal-TTL or CMOS compatible.
OUT	Output	Driver Output. For application purposes, this pin is connected via an external resistor to a Gate of a MOSFET/IGBT.
GND	Ground	The system ground pin. Internally connected to all circuitry, this pin provides ground reference for the entire chip. This pin should be connected to a low noise analog ground plane for optimum performance.

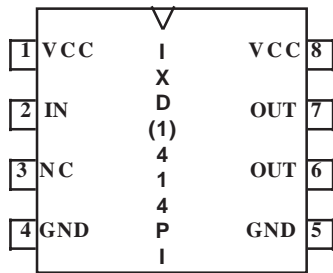

8 PIN DIP (PI)

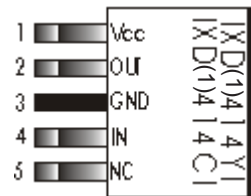

TO220 (CI)  
TO263 (YI)

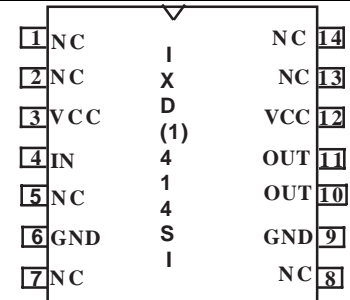

14 PIN SOIC

ORDERING INFORMATION			
Part Number	Package Type	Temp. Range	Configuration
IXDN414PI	8-Pin PDIP	-55°C to 125°C	Non Inverting
IXDN414SI	14-Pin SOIC		
IXDN414CI	5-Pin TO-220		
IXDN414YI	5-Pin TO-263		
IXDI414PI	8-Pin PDIP	-55°C to 125°C	Inverting
IXDI414SI	14-Pin SOIC		
IXDI414CI	5-Pin TO-220		
IXDI414YI	5-Pin TO-263		

NOTES 1: Either "I" or "N";

2: Mounting or solder tabs on all packages are connected to ground

\* Patent Pending

**Absolute Maximum Ratings (Note 1)**

Parameter	Value
Supply Voltage	40V
All Other Pins	-0.3V to $V_{CC} + 0.3V$
Power Dissipation	
$T_{CASE} \leq 25^{\circ}C$ : TO220 (CI), TO263 (YI)*	12.5W
Power Dissipation, $T_{AMBIENT} \leq 25^{\circ}C$	
8 Pin PDIP (PI), 14 Pin SOIC	833mW
TO220 (CI) TO263 (YI)	2W
Storage Temperature	-55 $^{\circ}C$ to 150 $^{\circ}C$
Soldering Lead Temperature (10s)	300 $^{\circ}C$
Tab Temperature (10s)	260 $^{\circ}C$

**Operating Ratings**

Parameter	Value
Maximum Junction Temperature	150 $^{\circ}C$
Operating Temperature Range	-55 $^{\circ}C$ to 125 $^{\circ}C$
Thermal Resistance (Junction To Case)	
TO220 (CI)	
TO263 (YI), 14 Pin SOIC (SI)	10 K/W
Thermal Resistance (Junction to Ambient)	
8-Pin PDIP (PI)	150 K/W
14-Pin SOIC	120 K/W
TO-220 (CI), TO-263 (YI)	62.5 K/W

\* Subject to internal lead current limit  $I_{DC}$

**Electrical Characteristics**

Unless otherwise noted,  $T_A = 25^{\circ}C$ ,  $4.5V \leq V_{CC} \leq 35V$ .

All voltage measurements with respect to GND. Device configured as described in *Test Conditions*.

Symbol	Parameter	Test Conditions	Min	Typ	Max	Units
$V_{IH}$	High input voltage	$4.5V \leq V_{CC} \leq 18V$	3.5			V
$V_{IL}$	Low input voltage	$4.5V \leq V_{CC} \leq 18V$			0.8	V
$V_{IN}$	Input voltage range		-5		$V_{CC} + 0.3$	V
$I_{IN}$	Input current	$0V \leq V_{IN} \leq V_{CC}$	-10		10	$\mu A$
$V_{OH}$	High output voltage		$V_{CC} - 0.025$			V
$V_{OL}$	Low output voltage				0.025	V
$R_{OH}$	Output resistance @ Output high	$I_{OUT} = 10mA$ , $V_{CC} = 18V$		600	1000	$m\Omega$
$R_{OL}$	Output resistance @ Output Low	$I_{OUT} = 10mA$ , $V_{CC} = 18V$		600	1000	$m\Omega$
$I_{PEAK}$	Peak output current	$V_{CC}$ is 18V		14		A
$I_{DC}$	Continuous output current	8 Pin Dip (PI) (Limited by pkg power dissipation) TO220 (CI), TO263 (YI)			3 4	A A
$t_R$	Rise time <sup>(1)</sup>	$C_L = 15nF$ $V_{CC} = 18V$		22	27	ns
$t_F$	Fall time <sup>(1)</sup>	$C_L = 15nF$ $V_{CC} = 18V$		20	25	ns
$t_{ONDLY}$	On-time propagation delay <sup>(1)</sup>	$C_L = 15nF$ $V_{CC} = 18V$		30	33	ns
$t_{OFFDLY}$	Off-time propagation delay <sup>(1)</sup>	$C_L = 15nF$ $V_{CC} = 18V$		31	34	ns
$V_{CC}$	Power supply voltage		4.5	18	35	V
$I_{CC}$	Power supply current	$V_{IN} = 3.5V$ $V_{IN} = 0V$ $V_{IN} = + V_{CC}$		1 0	3 10 10	$mA$ $\mu A$ $\mu A$

<sup>(1)</sup> See Figures 3a and 3b

**Note 1:** Operating the device beyond parameters with listed "Absolute Maximum Ratings" may cause permanent damage to the device. Typical values indicate conditions for which the device is intended to be functional, but do not guarantee specific performance limits. The guaranteed specifications apply only for the test conditions listed. Exposure to absolute maximum rated conditions for extended periods may affect device reliability.

**CAUTION:** These devices are sensitive to electrostatic discharge; follow proper ESD procedures when handling and assembling this component.

Specifications subject to change without notice

Figure 3a - Characteristics Test Diagram

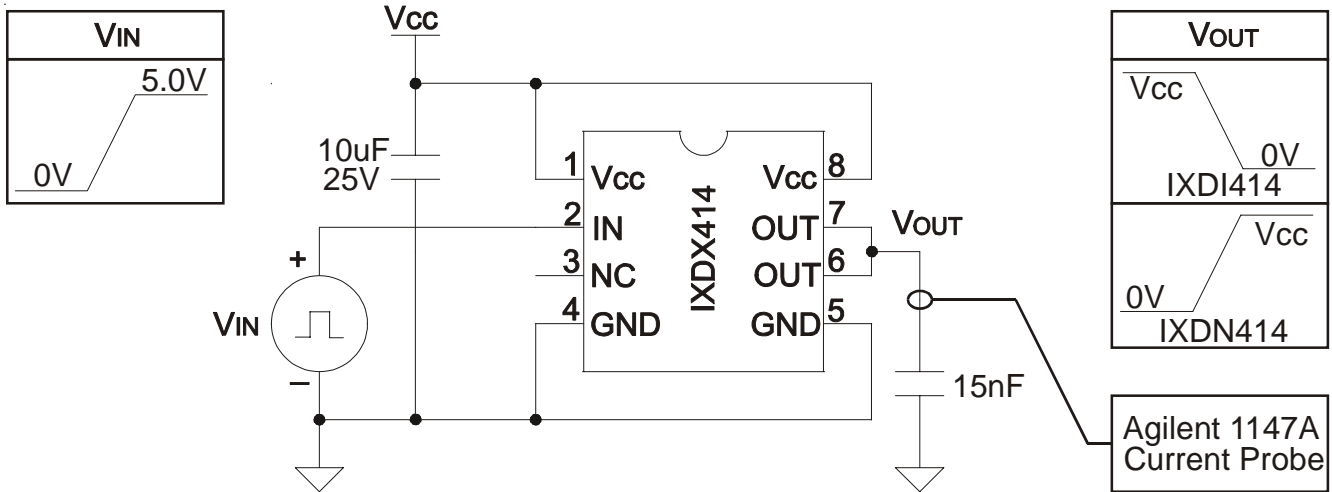
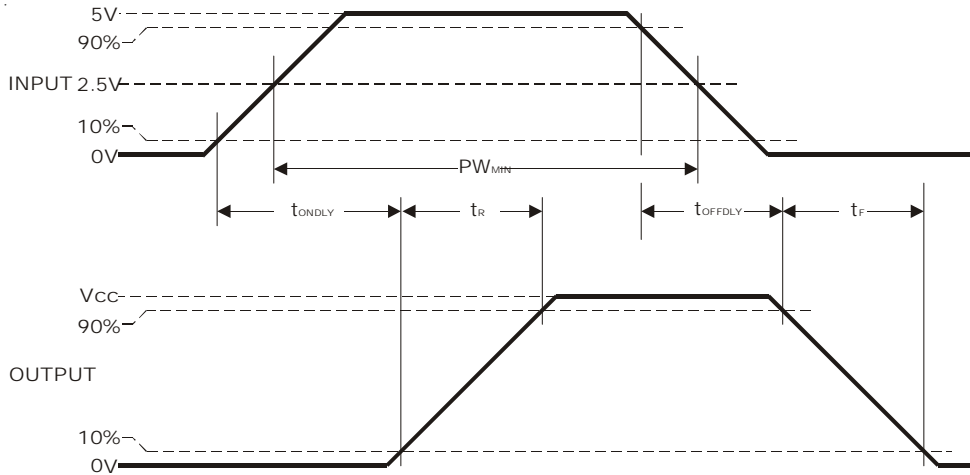
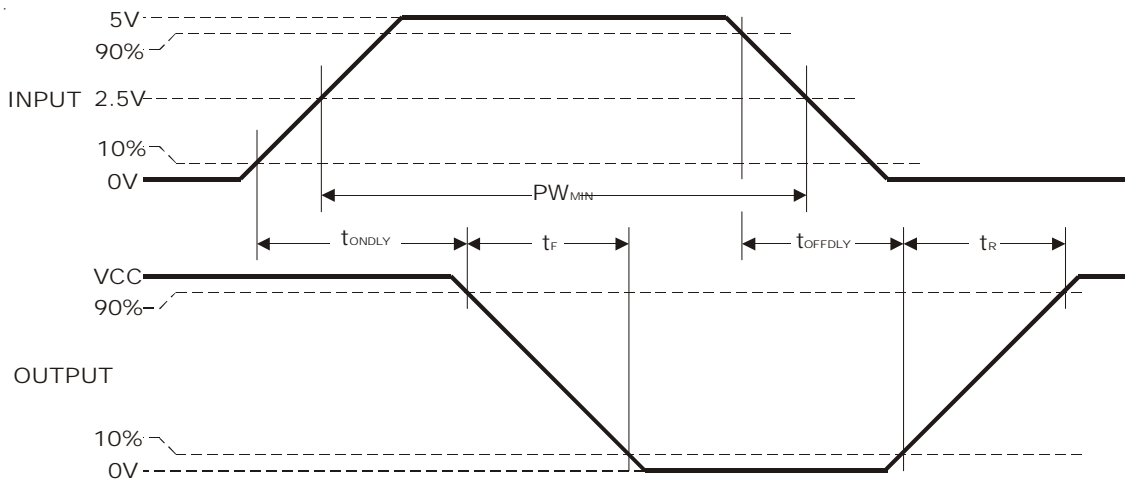

Figure 3b - Timing Diagrams

Non-Inverting (IXDN414) Timing Diagram



Inverting (IXDI414) Timing Diagram



Typical Performance Characteristics

Fig. 4 Rise Time vs. Supply Voltage

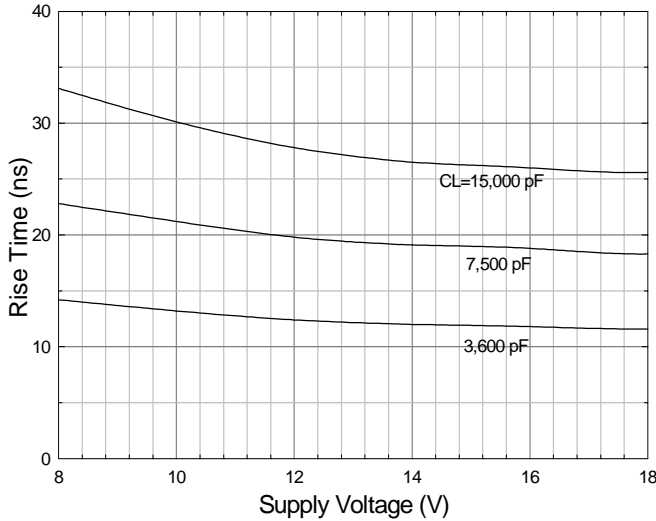

Fig. 5 Fall Time vs. Supply Voltage

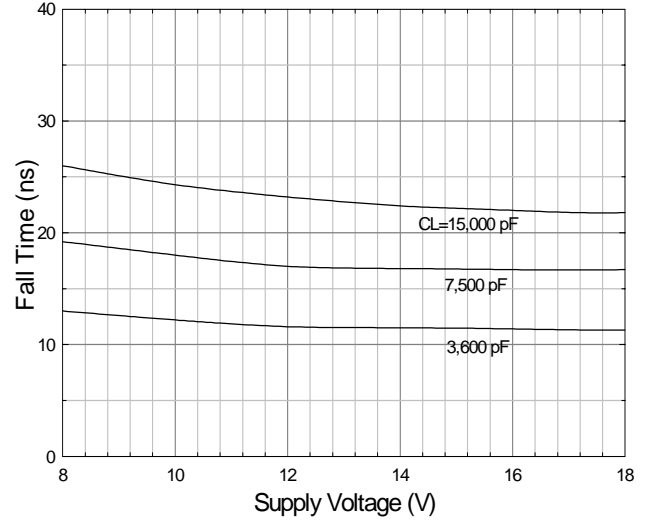

Fig. 6 Rise And Fall Times vs. Case Temperature  
 $C_L = 15 \text{ nF}$ ,  $V_{CC} = 18\text{V}$

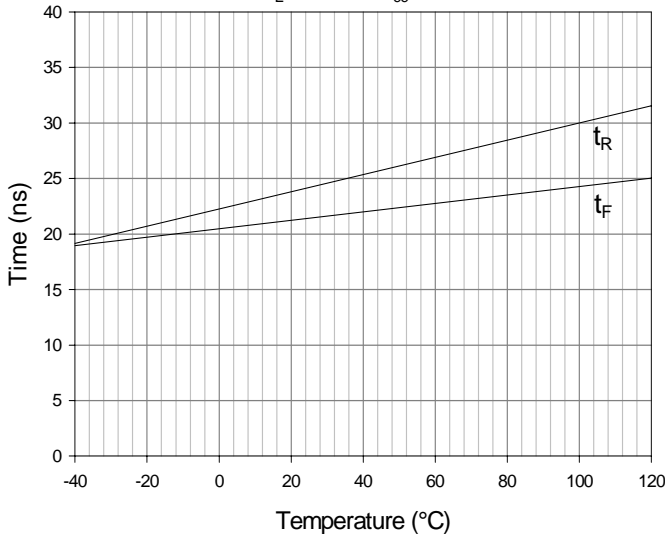

Fig. 7 Rise Time vs. Load Capacitance

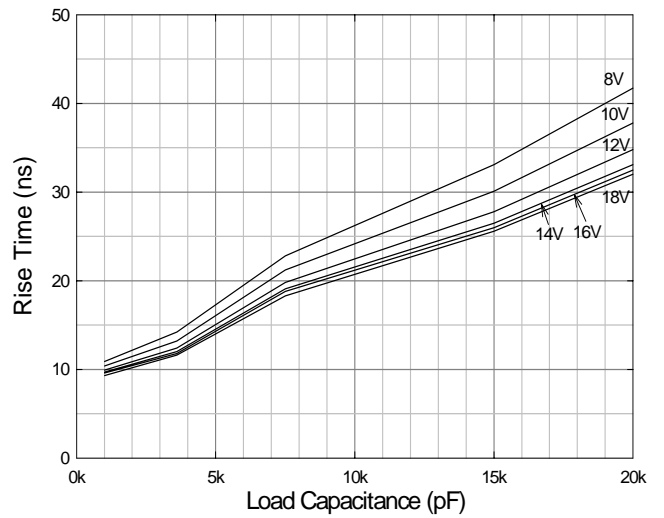

Fig. 8 Fall Time vs. Load Capacitance

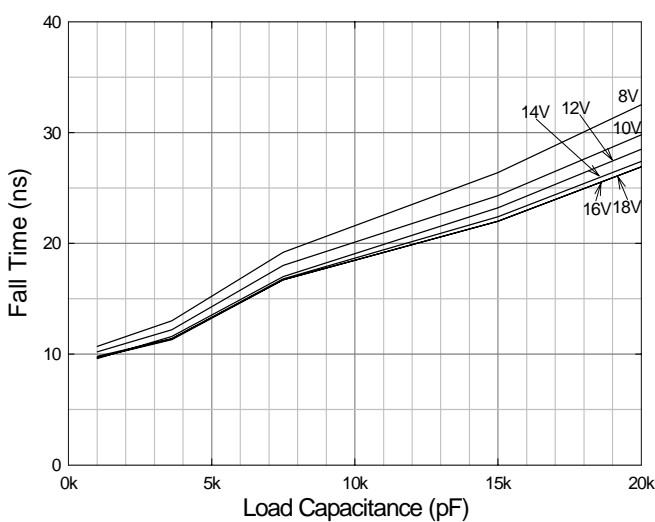

Fig. 9 Max / Min Input vs. Case Temperature  
 $V_{CC} = 18\text{V}$ ,  $C_L = 15\text{nF}$

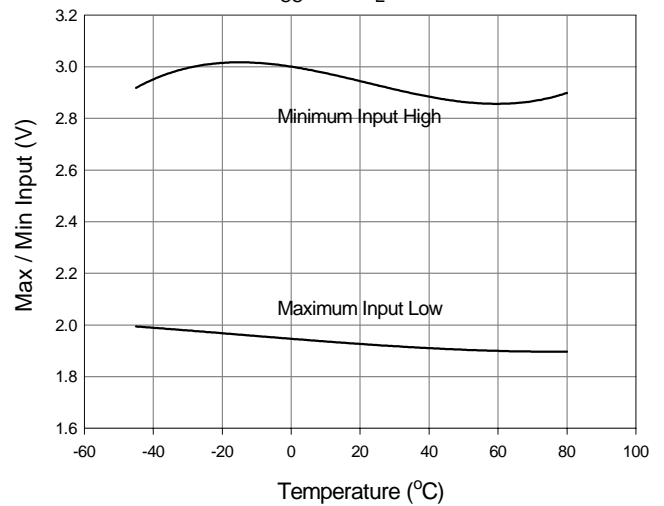

Fig. 11 Supply Current vs. Load Capacitance  
 $V_{CC}=18V$

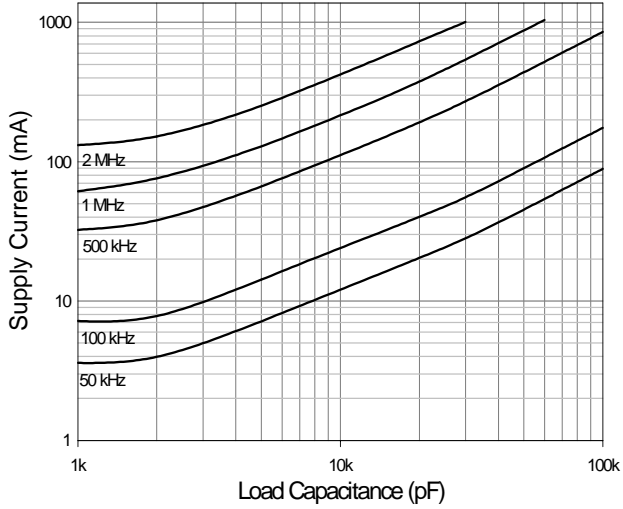

Fig. 12 Supply Current vs. Frequency  
 $V_{CC}=18V$

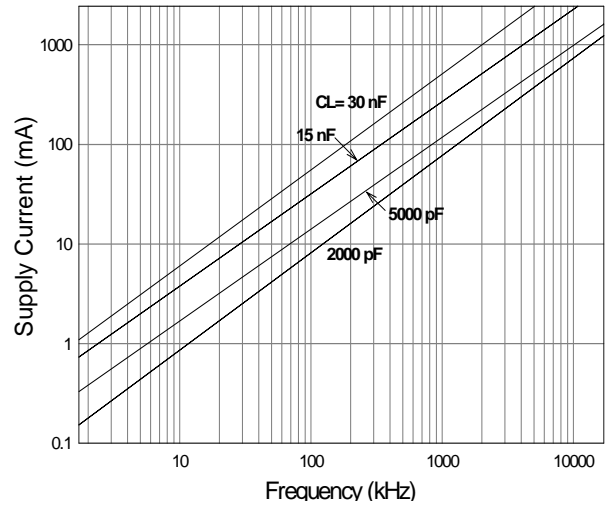

Fig. 13 Supply Current vs. Load Capacitance  
 $V_{CC}=12V$

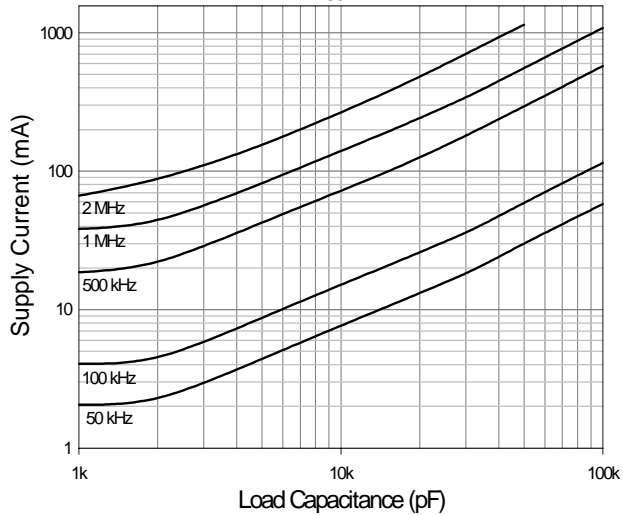

Fig. 14 Supply Current vs. Frequency  
 $V_{CC}=12V$

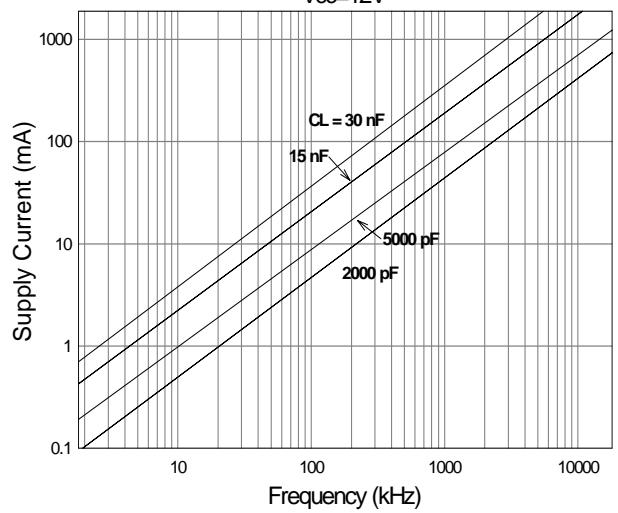

Fig. 15 Supply Current vs. Load Capacitance  
 $V_{CC}=8V$

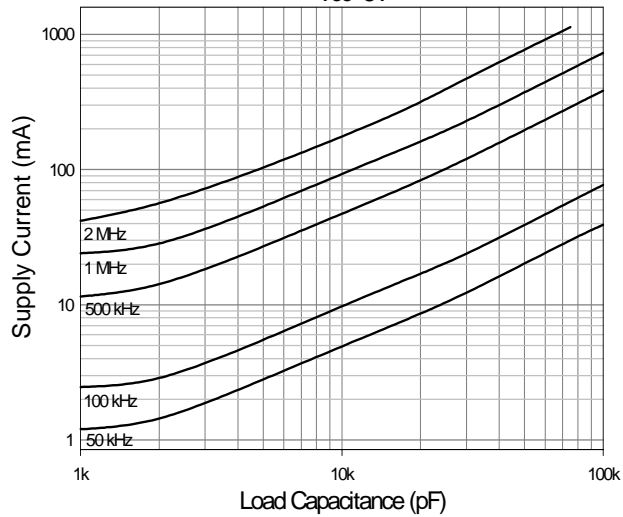

Fig. 16 Supply Current vs. Frequency  
 $V_{CC}=8V$

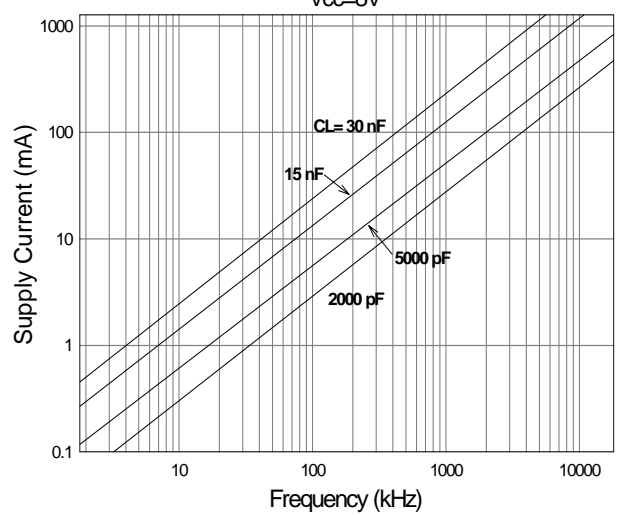

Fig. 17 Propagation Delay vs. Supply Voltage  
 $C_L=15nF$   $V_{IN}=5V@1kHz$

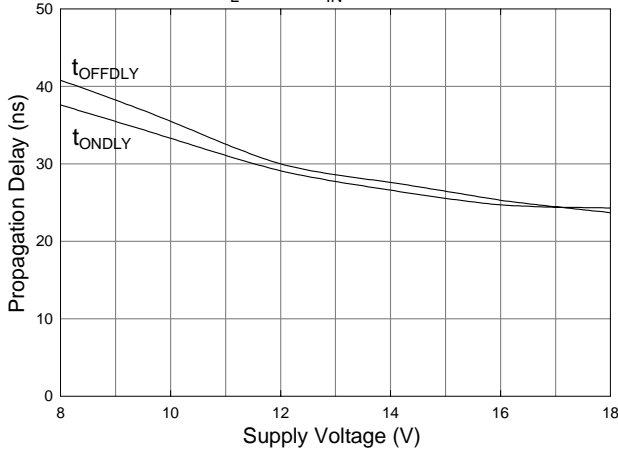

Fig. 18 Propagation Delay vs. Input Voltage  
 $C_L=15nF$   $V_{CC}=15V$

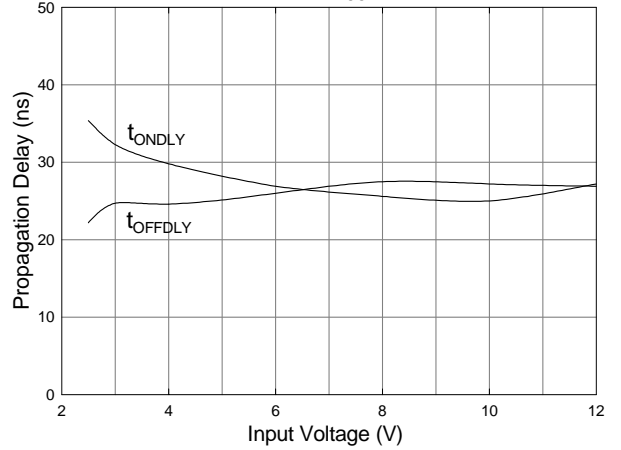

Fig. 19 Propagation Delay vs. Case Temperature  
 $C_L = 2500pF$ ,  $V_{CC} = 18V$

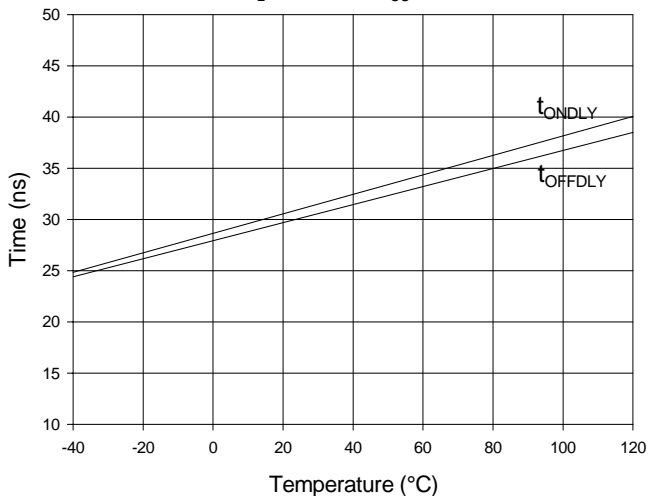

Fig. 20 Quiescent Supply Current vs. Case Temperature  
 $V_{CC}=18V$   $V_{IN}=5V@1kHz$

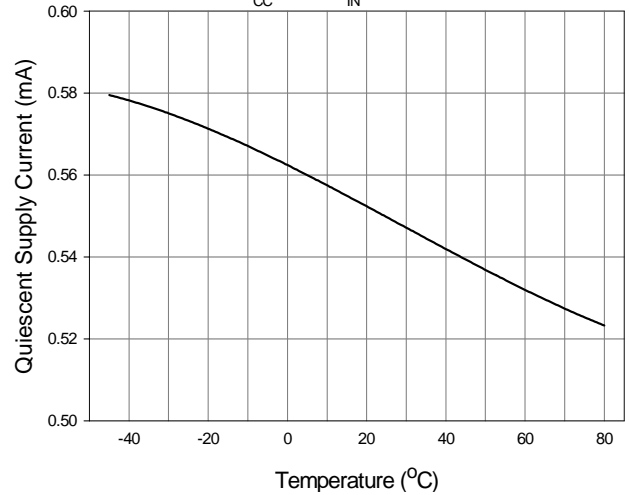

Fig. 21 P Channel Output Current vs. Case Temperature  
 $V_{CC}=18V$   $C_L=.1\mu F$

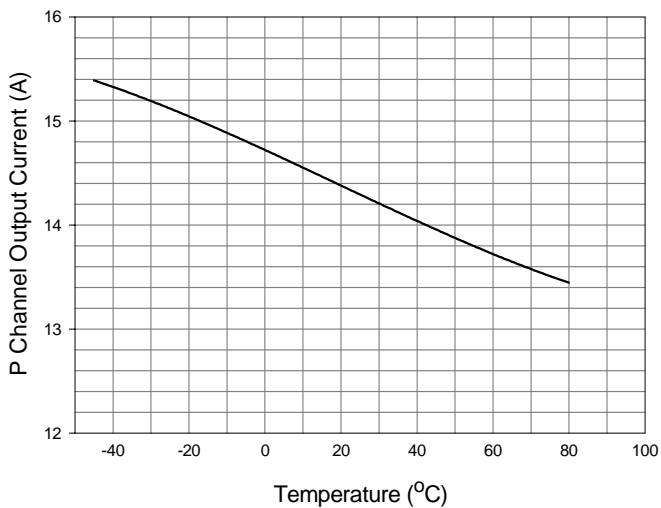

Fig. 22 N Channel Output Current vs. Case Temperature  
 $V_{CC}=18V$   $C_L=.1\mu F$

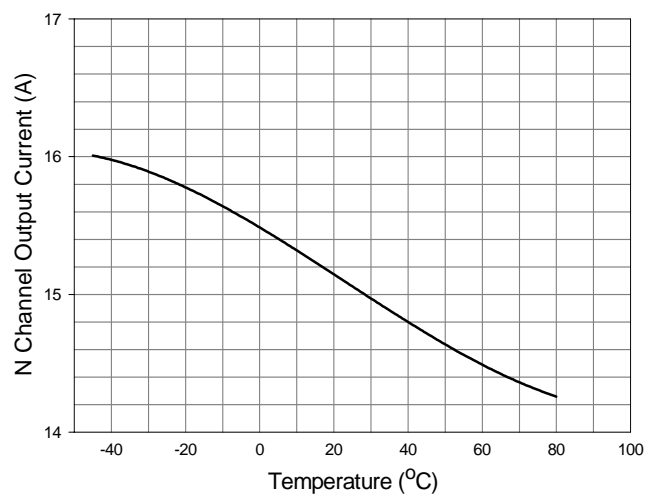

Fig. 23 Enable Threshold vs. Supply Voltage

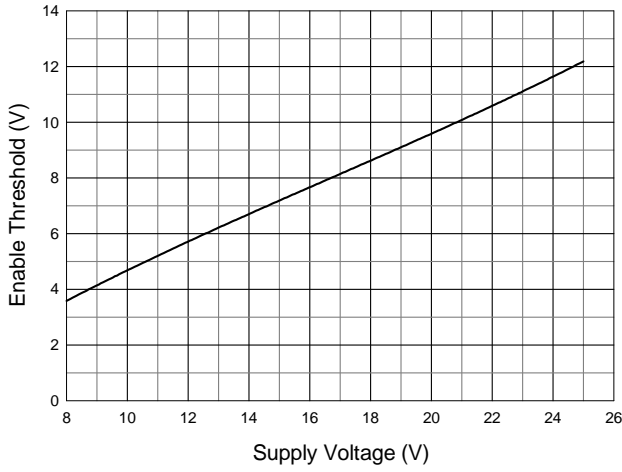

Fig. 24 High State Output Resistance vs. Supply Voltage

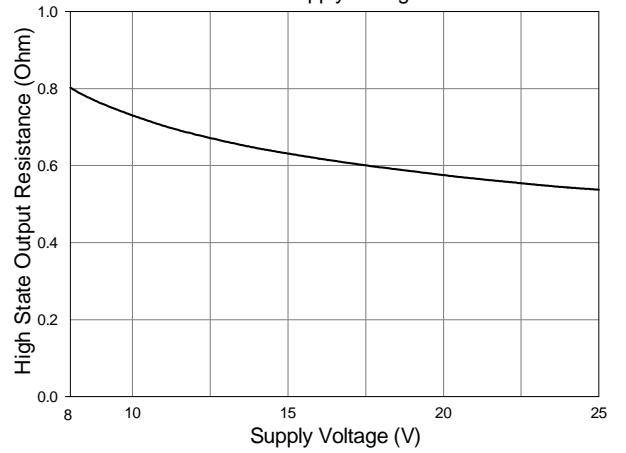

Fig. 25 Low-State Output Resistance vs. Supply Voltage

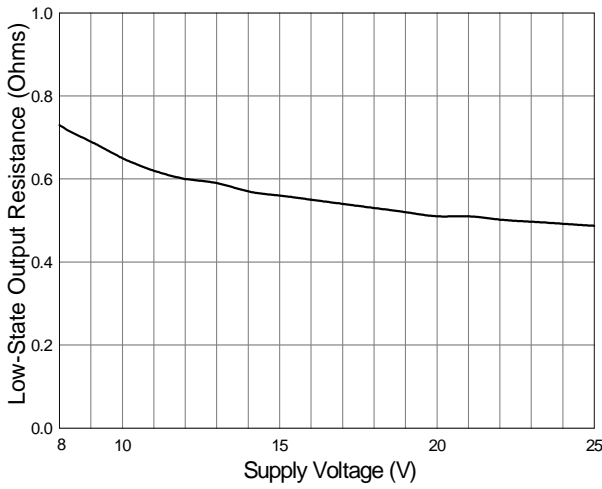

Fig. 26  $V_{CC}$  vs. P Channel Output Current  
 $C_L = 1\mu F$   $V_{IN} = 0-5V @ 1kHz$

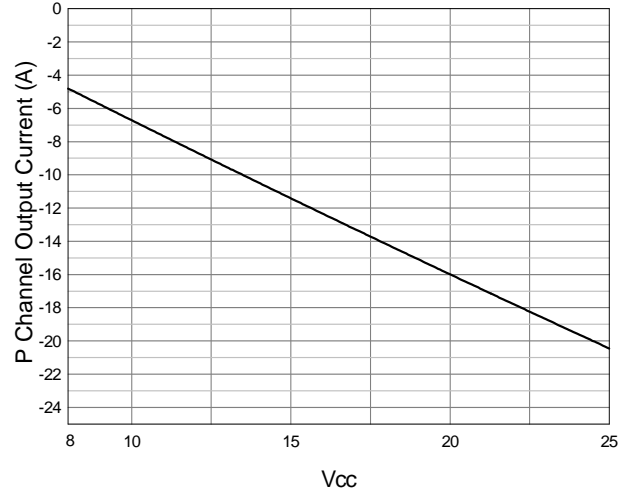
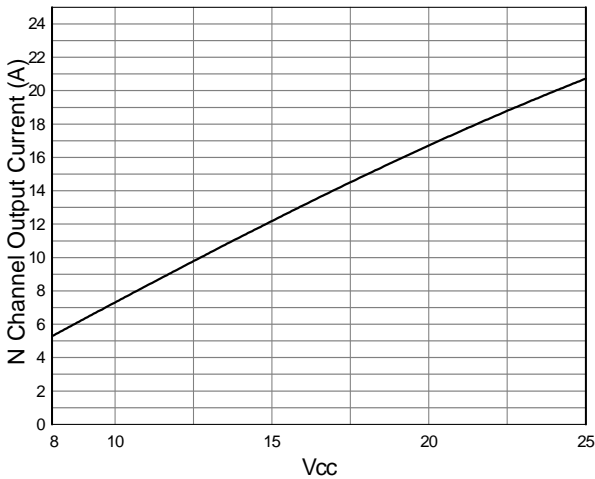

Fig. 27  $V_{CC}$  vs. N Channel Output Current  
 $C_L = 1\mu F$   $V_{IN} = 0-5V @ 1kHz$





---

## Supply Bypassing, Grounding Practices and Output Lead inductance

When designing a circuit to drive a high speed MOSFET utilizing the IXDN414/IXDI414, it is very important to observe certain design criteria in order to optimize performance of the driver. Particular attention needs to be paid to **Supply Bypassing, Grounding**, and minimizing the **Output Lead Inductance**.

Say, for example, we are using the IXDN414 to charge a 5000pF capacitive load from 0 to 25 volts in 25ns.

Using the formula:  $I = \Delta V C / \Delta t$ , where  $\Delta V = 25V$ ,  $C = 5000pF$  &  $\Delta t = 25ns$  we can determine that to charge 5000pF to 25 volts in 25ns will take a constant current of 5A. (In reality, the charging current won't be constant, and will peak somewhere around 8A).

### **SUPPLY BYPASSING**

In order for our design to turn the load on properly, the IXDN414 must be able to draw this 5A of current from the power supply in the 25ns. This means that there must be very low impedance between the driver and the power supply. The most common method of achieving this low impedance is to bypass the power supply at the driver with a capacitance value that is a magnitude larger than the load capacitance. Usually, this would be achieved by placing two different types of bypassing capacitors, with complementary impedance curves, very close to the driver itself. (These capacitors should be carefully selected, low inductance, low resistance, high-pulse current-service capacitors). Lead lengths may radiate at high frequency due to inductance, so care should be taken to keep the lengths of the leads between these bypass capacitors and the IXDN414 to an absolute minimum.

### **GROUNDING**

In order for the design to turn the load off properly, the IXDN414 must be able to drain this 5A of current into an adequate grounding system. There are three paths for returning current that need to be considered: Path #1 is between the IXDN414 and its load. Path #2 is between the IXDN414 and its power supply. Path #3 is between the IXDN414 and whatever logic is driving it. All three of these paths should be as low in resistance and inductance as possible, and thus as short as practical. In addition, every effort should be made to keep these three ground paths distinctly separate. Otherwise, the returning ground current from the load may develop a voltage that would have a detrimental effect on the logic line driving the IXDN414.

### **OUTPUT LEAD INDUCTANCE**

Of equal importance to Supply Bypassing and Grounding are issues related to the Output Lead Inductance. Every effort should be made to keep the leads between the driver and its load as short and wide as possible. If the driver must be placed farther than 2" (5mm) from the load, then the output leads should be treated as transmission lines. In this case, a twisted-pair should be considered, and the return line of each twisted pair should be placed as close as possible to the ground pin of the driver, and connected directly to the ground terminal of the load.

**8-PIN DIP Case Outline (IXD\_414PI)**

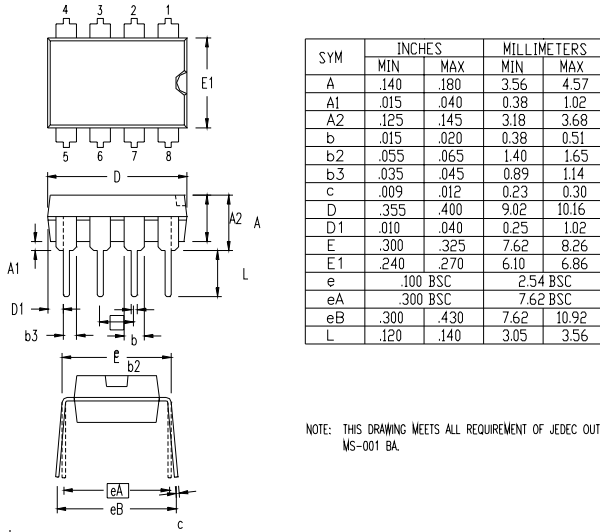

**14-PIN SOIC Case Outline (IXD\_414SI)**

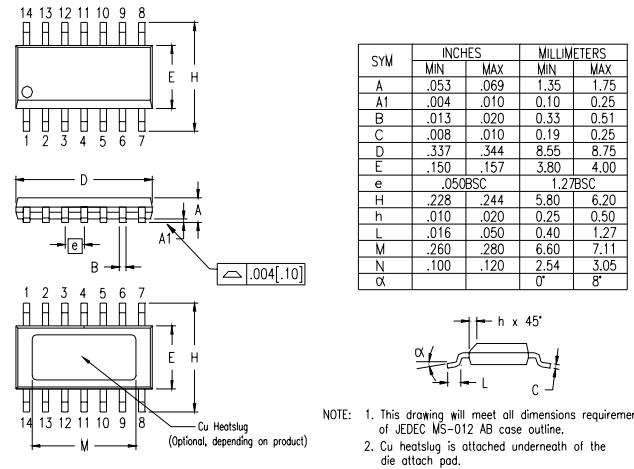

**5-Leaded TO-220 Case Outline (IXD\_414CI)**

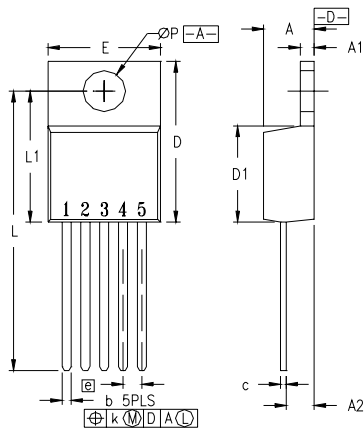

SYM	INCHES		MILLIMETERS	
	MIN	MAX	MIN	MAX
A	.170	.190	4.32	4.83
A1	.045	.055	1.14	1.40
A2	.090	.115	2.29	2.92
b	.025	.040	0.64	1.02
c	.015	.025	0.38	0.64
D	.580	.620	14.73	15.75
D1	.340	.370	8.64	9.40
E	.390	.415	9.91	10.54
e	.067 BSC		1.70 BSC	
k	0	.014	0	0.36
L	.995	1.045	25.27	26.54
L1	.470	.510	11.94	12.95
P	.139	.156	3.53	3.96

NOTE: This drawing will meet all dimensions requirement of JEDEC outlines TS-001AA and 5 lead version TO-220AB.

**5-Leaded TO-263 Case Outline (IXD\_414YI)**

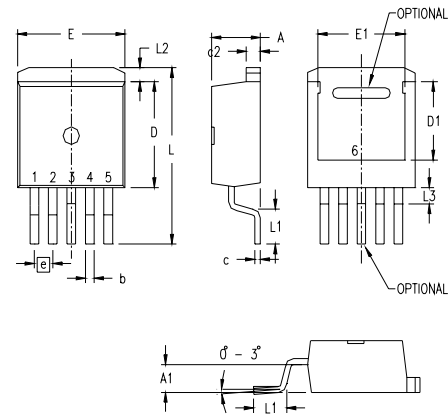

SYM	INCHES		MILLIMETERS	
	MIN	MAX	MIN	MAX
A	.165	.189	4.20	4.80
A1	.083	.106	2.10	2.70
b	.024	.039	0.60	0.99
c	.016	.028	0.40	0.70
c2	.047	.055	1.20	1.40
D	.346	.374	8.80	9.50
D1	.260	.283	6.60	7.20
E	.380	.406	9.65	10.30
E1	.295	.323	7.50	8.20
e	.067 BSC		1.70 BSC	
L	.583	.622	14.80	15.80
L1	.088	.112	2.24	2.84
L2	.039	.055	1.00	1.40
L3	.047	.067	1.20	1.70

1. All metal surface are solder plated except trimmed area.
2. Short lead of No. 3 is optional of IXYS.
3. No. 3 lead is connected to No. 6 lead (bottom heat sink) internally.