

M0116LY-161SA1

Vacuum Fluorescent Display Module

RoHS Compliant

Newhaven Display International, Inc.

2511 Technology Drive, Suite 101

Elgin IL, 60124

Ph: 847-844-8795

Fax: 847-844-8796

www.newhavendisplay.com

nhtech@newhavendisplay.com

nhsales@newhavendisplay.com

APPLICATION NOTE

VACUUM FLUORESCENT DISPLAY MODULE



CHARACTER DISPLAY MODULE

M0116LY-161LSA1 - INSTRUCTION MANUAL □

The Newhaven Vacuum Fluorescent Display module M0116LY-161LSA1 Newhaven VFD M0116LY display, produces 1 row x 16 digits in an Alphanumeric format. The module can be operated by a simple serial synchronous interface. +5Vdc input voltage required.

Page 1 of 11

| REV. NO. | SPEC. ID. | Division | DATE | SIGNATURE |
|----------|-----------------|----------|----------|-----------|
| 02 | M0116LY-161LSA1 | VFD | 10/31/06 | GRM |
| | | | | Approval |

| | | | | |
|----------|---|-----------------|--------|---------|
| STANDARD |  | DOCUMENT NO. | REV.NO | PAGE |
| | | M0116LY-161LSA1 | 02 | 2 of 11 |

1. INTRODUCTION

The M0116LY Vacuum Fluorescent Display module consists of a 1 row x 16 digit display with one chip controller on board.

2. FEATURES

- 2.1 Simple connection to the host system data bus via two-wire clocked serial interface.
- 2.2 Since a DC/DC converter is used, only +5Vdc power source is required to operate the module.
- 2.3 One chip controller offers integral 64×16 bit programmable logic array, low power consumption and high reliability in services.
- 2.4 32 brightness levels can be selected by brightness control command.
- 2.5 High quality blue-green(505nm) vacuum fluorescent display provides an attractive and readable medium. Other colors can be achieved by simple wavelength filters.
- 2.6 Characters are provided in an attractive 16-segment starburst format.

3. GENERAL DESCRIPTIONS

- 3.1 This specification becomes effective after being approved by the purchaser.
- 3.2 When any conflict is found in the specification ,appropriate action shall be taken upon agreement of both parties.
- 3.3 The expected necessary service parts should be arranged by the customer before the completion of production.

4. PRODUCT SPECIFICATIONS

4.1 Type

Table-1

| | |
|--------------|--------------------------------|
| Type | M0116LY-161LSA1 |
| Digit Format | 16 Seg. & Comma, Decimal Point |

4.2 Outer Dimensions, Weight (See Fig-4 on Page 4/12 for details)

Table-2

| Parameter | | Specification | Unit |
|------------------|-----------|---------------|------|
| Outer Dimensions | Width | 218.0±1.0 | mm |
| | Height | 45.0±1.0 | mm |
| | Thickness | 26.5 Max | mm |
| Weight | | Typical 130 | g |

| | | | | |
|----------|---|-----------------|--------|---------|
| STANDARD |  | DOCUMENT NO. | REV.NO | PAGE |
| | | M0116LY-16ILSA1 | 02 | 3 of 11 |

4.3 Specification of Display Panel (See Fig-5 on Page 5/13)

Table-3

| Parameter | Symbol | Specification | Unit |
|----------------------|--------------------|--------------------------|------|
| Display Size (W×H) | - | 173.6×14.25 | mm |
| Number of Digit | - | 16 Digits | - |
| Character Size (W×H) | - | 7.0×12.50 | mm |
| Character Pitch | C _p (x) | 11.0 | mm |
| Display Color | - | Blue-Green (Peak 505 nm) | mm |

4.4 Environment Conditions

Table-4

| Parameter | Symbol | Min | Max | Unit |
|--------------------------|--------|-----|-----|------|
| Operating Temperature | Topr | -40 | +85 | °C |
| Storage Temperature | Tstg | -50 | +95 | °C |
| Humidity (Operating) | Hopr | 0 | 85 | % |
| Humidity (Non-operating) | Hstg | 0 | 90 | % |
| Vibration (10~55Hz) | - | - | 4 | G |
| Shock | - | - | 40 | G |

4.5 Absolute Maximum Ratings

Table-5

| Parameter | Symbol | Min | Max. | Unit |
|----------------------|-----------------|------|------|-----------------|
| Supply Voltage | V _{cc} | - | 7.0 | V _{dc} |
| Input Signal Voltage | V _{is} | -0.4 | 5.5 | V _{dc} |

4.6 Recommend Operating Conditions

Table-6

| Parameter | Symbol | Min | Typ. | Max. | Unit |
|-----------------------|-----------------|-----|------|------|-----------------|
| Supply Voltage | V _{cc} | 4.5 | 5.0 | 5.5 | V _{dc} |
| H-Level Input Voltage | V _{ih} | 2.0 | - | - | V _{dc} |
| L-Level Input Voltage | V _{il} | - | - | 0.8 | V _{dc} |

4.7 DC Characteristics (T_a=+25°C, V_{cc}=+5.0V_{dc})

Table-7

| Parameter | Symbol | Min. | Typ. | Max. | Unit |
|-----------------------|-----------------|------|------|-------|------|
| Supply current ※) | I _{cc} | - | 600 | 800 | mA |
| H-Level Input Current | I _{ih} | - | - | 20.0 | μA |
| L-Level Input Current | I _{il} | - | - | -0.36 | μA |
| Lumilance | L | 100 | 200 | - | ft-L |

※) The surge current can be approx. 3 times the specified supply current at power on.

4.8 Timing Chart

4.8.1 SCLK and DATA Timing

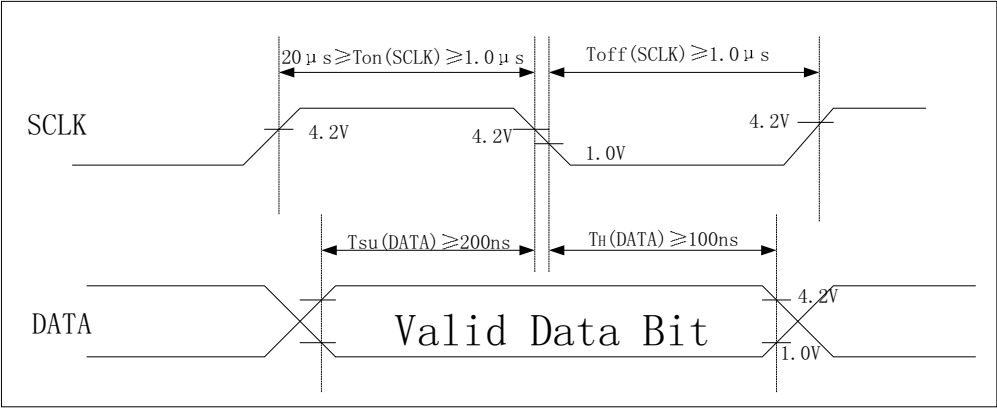

Fig-1. SCLK and Serial DATA Timing Diagram

4.8.2 Data word LSB/MSB Timing

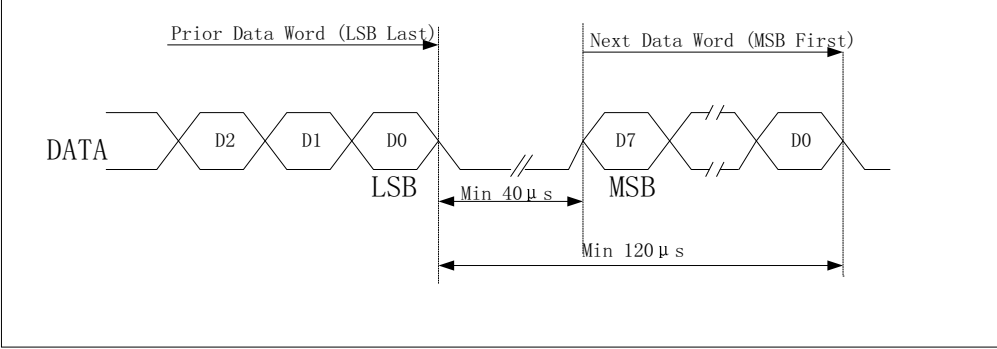

Fig-2 Data Word LSB/MSB Timing Diagram

4.9 Signal Interfacing

Connector (Male): PH-2S06-FG (by Aster) or equivalent

→ Make Socket(Female) : HIF3B-12D-2.54R (HIOROSE) or equivalent

Table-8

| Pin # | Signal | Pin # | Signal | Signal Name Description |
|-------|--------|-------|--------|--|
| 1 | Vcc | 2 | Vcc | Vcc : Power Supply Terminal. (+5Vdc is required.) |
| 3 | N/P | 4 | N/C | N/P : No Pin, N/C : No Connection. |
| 5 | N/C | 6 | N/C | N/C: No Connection. |
| 7 | N/C | 8 | SCLK | SCLK : Shift Clock of Shift Register. (Falling Edge Active) |
| 9 | DATA | 10 | /RST | DATA :Input Terminal for Display or Control Codes. /RST :Input Terminal for Reset of VFD Module. (Low Active) |
| 11 | GND | 12 | GND | GND : Ground Terminal. |

4.10 System Block Diagram

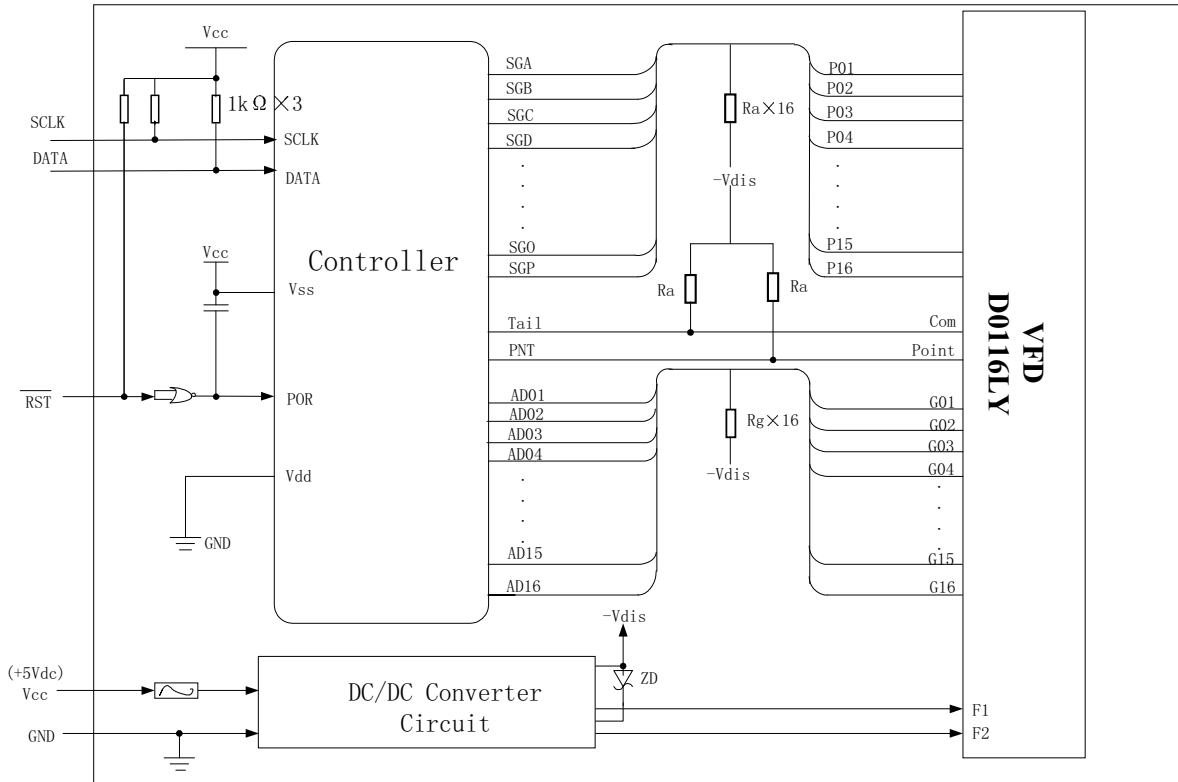

Fig-3 VFD Module System Block Diagram

4.11 Outer Dimensions

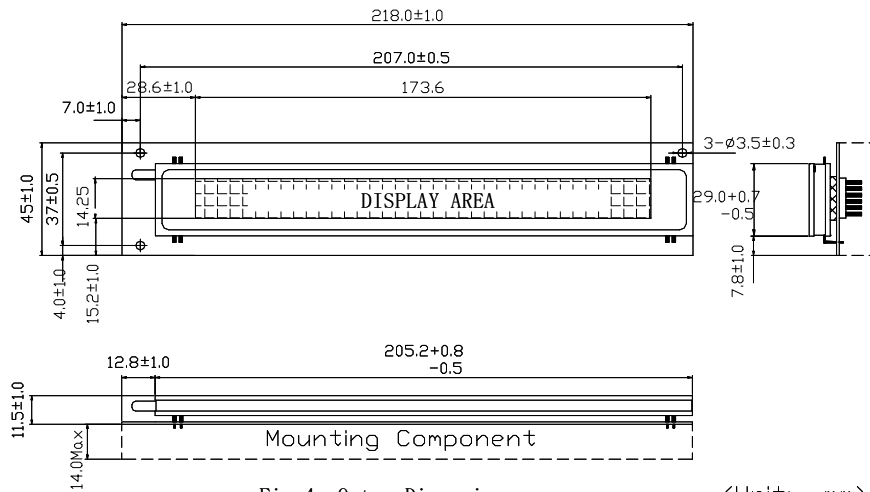

Fig-4. Outer Dimensions

(Unit: mm)

4.12 Pattern Details

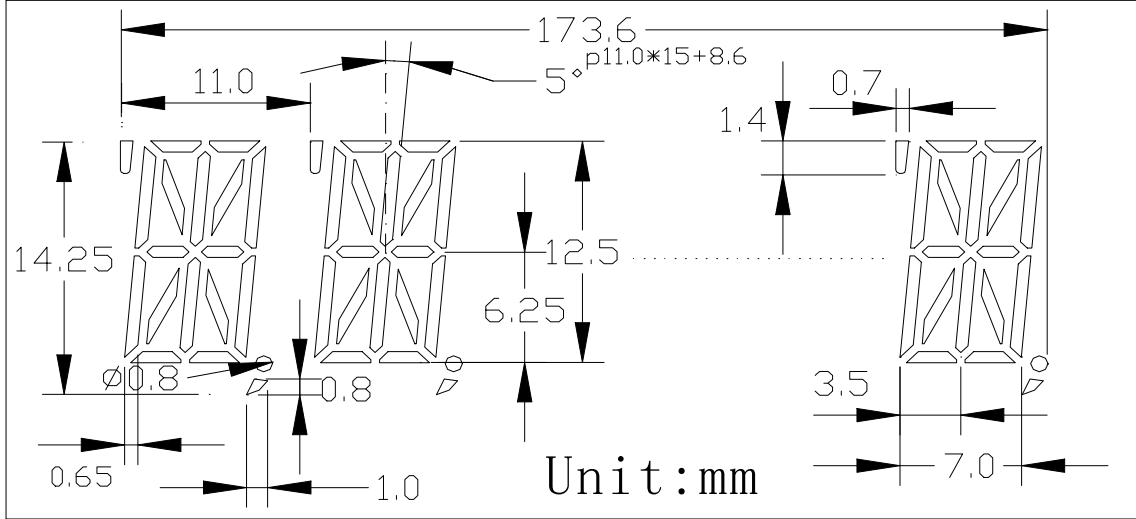

Fig-5. Pattern Details

5 FUNCTIONS

The module has control data, display data write and reset functions. Input data from the host system is loaded into the module's display buffer via the serial data input channel as 8-bit serial data.

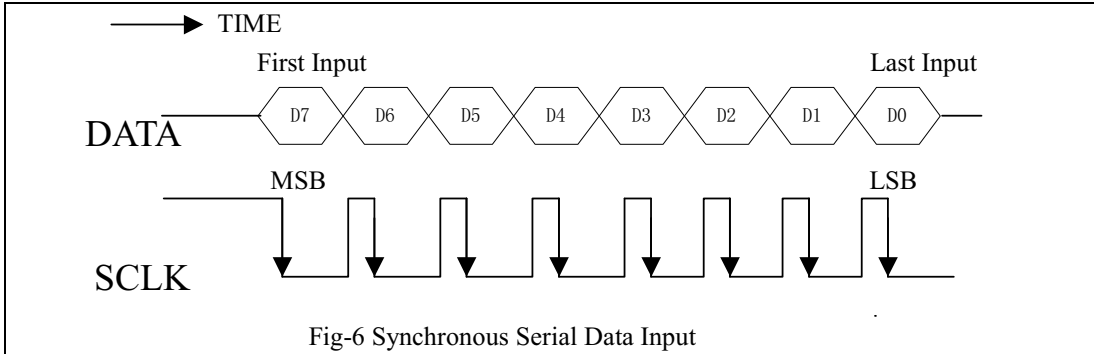

Fig-6 Synchronous Serial Data Input

The MSB value of 8-bit serial data determines whether the input data into this module is control data or display data.

5.1 Control Data

The control data can be input by setting MSB to "1" : In addition, a command type and associated data with the command is determined by the D6~D0.

| Command | Function | Binary Code | | | | | | | |
|------------------------|----------------------------|-------------|----|----|----------------|----------------|----------------|----------------|----------------|
| | | D7 | D6 | D5 | D4 | D3 | D2 | D1 | D0 |
| Buffer Pointer Control | Specifies the RAM address. | 1 | 0 | 1 | 0 | 2 ³ | 2 ² | 2 ¹ | 2 ⁰ |
| Digit Counter Control | Sets the number of digits. | 1 | 1 | 0 | 0 | 2 ³ | 2 ² | 2 ¹ | 2 ⁰ |
| Brightness Control | Sets the brightness. | 1 | 1 | 1 | 2 ⁴ | 2 ³ | 2 ² | 2 ¹ | 2 ⁰ |

5.1.1 Buffer Pointer Control

This command changes the display contents only at an arbitrary digit.

(The RAM write address is set.) The digit position to be modified is represented by the value of D3~D0. If the most significant digit(left-end digit) is to be selected, each of D3~D0 are set to a value of “1” and if the second digit is to be selected ,each of D3~D3 set to a value of “0”. Otherwise a decimal value of from “1”to “14” should be entered. The set value of D3~D0 is lower than the decimal value of the specified position by 2.

Table-10

| Digit | Binary Code | | | | | | | | Digit | Binary Code | | | | | | | |
|----------|-------------|----|----|----|----|----|----|----|-----------|-------------|----|----|----|----|----|----|----|
| | D7 | D6 | D5 | D4 | D3 | D2 | D1 | D0 | | D7 | D6 | D5 | D4 | D3 | D2 | D1 | D0 |
| Left End | 1 | 0 | 1 | 0 | 1 | 1 | 1 | 1 | 9th | 1 | 0 | 1 | 0 | 0 | 1 | 1 | 1 |
| 2nd | 1 | 0 | 1 | 0 | 0 | 0 | 0 | 0 | 10th | 1 | 0 | 1 | 0 | 1 | 0 | 0 | 0 |
| 3rd | 1 | 0 | 1 | 0 | 0 | 0 | 0 | 1 | 11th | 1 | 0 | 1 | 0 | 1 | 0 | 0 | 1 |
| 4th | 1 | 0 | 1 | 0 | 0 | 0 | 1 | 0 | 12th | 1 | 0 | 1 | 0 | 1 | 0 | 1 | 0 |
| 5th | 1 | 0 | 1 | 0 | 0 | 0 | 1 | 1 | 13th | 1 | 0 | 1 | 0 | 1 | 0 | 1 | 1 |
| 6th | 1 | 0 | 1 | 0 | 0 | 1 | 0 | 0 | 14th | 1 | 0 | 1 | 0 | 1 | 1 | 0 | 0 |
| 7th | 1 | 0 | 1 | 0 | 0 | 1 | 0 | 1 | 15th | 1 | 0 | 1 | 0 | 1 | 1 | 0 | 1 |
| 8th | 1 | 0 | 1 | 0 | 0 | 1 | 1 | 0 | Right End | 1 | 0 | 1 | 0 | 1 | 1 | 1 | 0 |

5.1.2 Digit Counter Control

This command is used to define the number of display digits. The code is normally used only during initialization routine of the host system.

If all 16 characters are to be controlled, each of D3~D0 are set to a value of “0”, otherwise a decimal value from “1” to “15” is entered, corresponding to the actual number of characters to be controlled.

Table-11

| Number of Display Digit | Binary Code | | | | | | | | Number of Display Digit | Binary Code | | | | | | | |
|-------------------------|-------------|----|----|----|----|----|----|----|-------------------------|-------------|----|----|----|----|----|----|----|
| | D7 | D6 | D5 | D4 | D3 | D2 | D1 | D0 | | D7 | D6 | D5 | D4 | D3 | D2 | D1 | D0 |
| 1 | 1 | 1 | 0 | 0 | 0 | 0 | 0 | 1 | 9 | 1 | 1 | 0 | 0 | 1 | 0 | 0 | 1 |
| 2 | 1 | 1 | 0 | 0 | 0 | 0 | 1 | 0 | 10 | 1 | 1 | 0 | 0 | 1 | 0 | 1 | 0 |
| 3 | 1 | 1 | 0 | 0 | 0 | 0 | 1 | 1 | 11 | 1 | 1 | 0 | 0 | 1 | 0 | 1 | 1 |
| 4 | 1 | 1 | 0 | 0 | 0 | 1 | 0 | 0 | 12 | 1 | 1 | 0 | 0 | 1 | 1 | 0 | 0 |
| 5 | 1 | 1 | 0 | 0 | 0 | 1 | 0 | 1 | 13 | 1 | 1 | 0 | 0 | 1 | 1 | 0 | 1 |
| 6 | | 1 | 0 | 0 | 0 | 1 | 1 | 0 | 14 | | 1 | 0 | 0 | 1 | 1 | 1 | 0 |
| 7 | 1 | 1 | 0 | 0 | 0 | 1 | 1 | 1 | 15 | 1 | 1 | 0 | 0 | 1 | 1 | 1 | 1 |
| 8 | 1 | 1 | 0 | 0 | 1 | 0 | 0 | 0 | 16 | 1 | 1 | 0 | 0 | 0 | 0 | 0 | 0 |

5.1.3 Brightness Control

This command sets the brightness of the VFD. This command allows the brightness to be adjusted by 1/32 step. As shown in Table-12, the test value ranges from 0 to 31.

Table-12

| Brightness Level | Binary Code | | | | | | | | Brightness Level | Binary Code | | | | | | | |
|---------------------|-------------|----|----|----|----|----|----|----|---------------------|-------------|----|----|----|----|----|----|----|
| | D7 | D6 | D5 | D4 | D3 | D2 | D1 | D0 | | D7 | D6 | D5 | D4 | D3 | D2 | D1 | D0 |
| 0/31(0.0%) | 1 | 1 | 1 | 0 | 0 | 0 | 0 | 0 | 16/31(51.6%) | 1 | 1 | 1 | 1 | 0 | 0 | 0 | 0 |
| 1/31(3.2%) | 1 | 1 | 1 | 0 | 0 | 0 | 0 | 1 | 17/31(54.8%) | 1 | 1 | 1 | 1 | 0 | 0 | 0 | 1 |
| 2/31(6.4%) | 1 | 1 | 1 | 0 | 0 | 0 | 1 | 0 | 18/31(58.1%) | 1 | 1 | 1 | 1 | 0 | 0 | 1 | 0 |
| 3/31(9.7%) | 1 | 1 | 1 | 0 | 0 | 0 | 1 | 1 | 19/31(61.2%) | 1 | 1 | 1 | 1 | 0 | 0 | 1 | 1 |
| 4/31(12.9%) | 1 | 1 | 1 | 0 | 0 | 1 | 0 | 0 | 20/31(64.5%) | 1 | 1 | 1 | 1 | 0 | 1 | 0 | 0 |
| 5/31(16.1%) | 1 | 1 | 1 | 0 | 0 | 1 | 0 | 1 | 21/31(67.7%) | 1 | 1 | 1 | 1 | 0 | 1 | 0 | 1 |
| 6/31(19.4%) | 1 | 1 | 1 | 0 | 0 | 1 | 1 | 0 | 22/31(71.0%) | 1 | 1 | 1 | 1 | 0 | 1 | 1 | 0 |
| 7/31(22.6%) | 1 | 1 | 1 | 0 | 0 | 1 | 1 | 1 | 23/31(74.2%) | 1 | 1 | 1 | 1 | 0 | 1 | 1 | 1 |
| 8/31(25.8%) | 1 | 1 | 1 | 0 | 1 | 0 | 0 | 0 | 24/31(77.4%) | 1 | 1 | 1 | 1 | 1 | 0 | 0 | 0 |
| 9/31(29.0%) | 1 | 1 | 1 | 0 | 1 | 0 | 0 | 1 | 25/31(80.6%) | 1 | 1 | 1 | 1 | 1 | 0 | 0 | 1 |
| 10/31(32.3%) | 1 | 1 | 1 | 0 | 1 | 0 | 1 | 0 | 26/31(83.9%) | 1 | 1 | 1 | 1 | 1 | 0 | 1 | 0 |
| 11/31(35.5%) | 1 | 1 | 1 | 0 | 1 | 0 | 1 | 1 | 27/31(87.1%) | 1 | 1 | 1 | 1 | 1 | 0 | 1 | 1 |
| 12/31(38.7%) | 1 | 1 | 1 | 0 | 1 | 1 | 0 | 0 | 28/31(90.3%) | 1 | 1 | 1 | 1 | 1 | 1 | 0 | 0 |
| 13/31(41.9%) | 1 | 1 | 1 | 0 | 1 | 1 | 0 | 1 | 29/31(93.5%) | 1 | 1 | 1 | 1 | 1 | 1 | 0 | 1 |
| 14/31(45.2%) | 1 | 1 | 1 | 0 | 1 | 1 | 1 | 0 | 30/31(96.8%) | 1 | 1 | 1 | 1 | 1 | 1 | 1 | 0 |
| 15/31(48.4%) | 1 | 1 | 1 | 0 | 1 | 1 | 1 | 1 | 31/31(100%) | 1 | 1 | 1 | 1 | 1 | 1 | 1 | 1 |

5.2 Input Display Data Word

Display data words are loaded into the display buffer of module as 8-bit codes, with the MSB set to "0". The 64 available codes are shown in Table-14 on page 9/12. 16 display data words must be entered to fully load the display data buffer. The display buffer pointer (write in position) specified by the buffer. Pointer control command is automatically incremented by one each time the display data is entered.

To set the comma or decimal point, the display data codes of 2C Hex or 2E Hex is entered respectively. Only when 2C Hex and 2E Hex data are entered, the display buffer pointer in the RAM is not automatically incremented but stays present location.

5.3 RESET

The reset function allows the users to re-initialize the alphanumeric display controller, while the power is still applied to the module, by applying a logical “0” to pin #10(/RST) of the connector. (Pulse Width \geq 100%)

When the controller is initialized, the display status are shown in Table-13. The RAM data (Display Buffer Data) are the same as the prior data.

Table-13

| Parameter | Reset Status | Binary Code | | | | | | | |
|-------------------------|----------------|-------------|----|----|----|----|----|----|----|
| | | D7 | D6 | D5 | D4 | D3 | D2 | D1 | D0 |
| Write in Position | Left End Digit | 1 | 0 | 1 | 0 | 1 | 1 | 1 | 1 |
| Number of Display Digit | 16 Digits | 1 | 1 | 0 | 0 | 0 | 0 | 0 | 0 |
| Brightness Level | 0% | 1 | 1 | 1 | 0 | 0 | 0 | 0 | 0 |





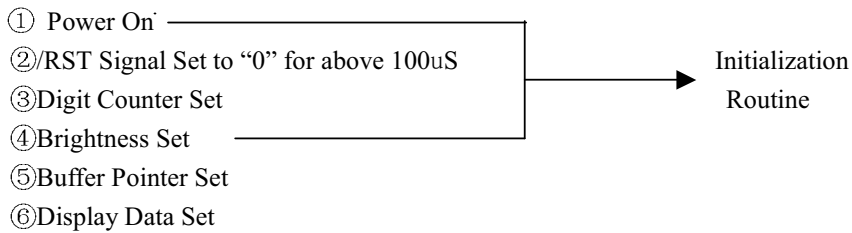





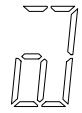
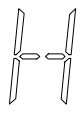
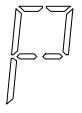
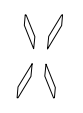

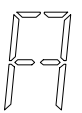
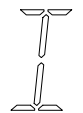
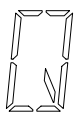

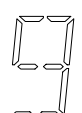
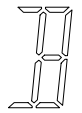
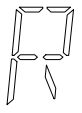
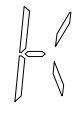
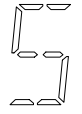

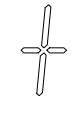
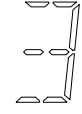

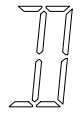
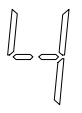
If automatic reset at time of power up is required, please contact NewHaven engineering prior to order placement.

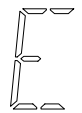
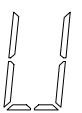
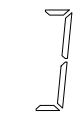
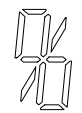
5.4 Data Set-up Flow



Character Font Table

Table-14

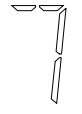
| MSB LSB | 0X000 | 0X001 | 0X010 | 0X011 | 0X100 | 0X101 | 0X110 | 0X111 |
|------------|---|---|---|---|--|---|---|---|
| 000 |  |  |  |  |  |  |  |  |
| 001 |  |  |  |  |  |  |  |  |
| 010 |  |  |  |  |  |  |  |  |
| 011 |  |  |  |  |  |  |  |  |
| 100 |  |  |  |  |  |  |  |  |
| 101 |  |  |  |  |  |  |  |  |
| 110 |  |  |  |  |  |  |  |  |
| 111 |  |  |  |  |  |  |  |  |

| | | | | |
|----------|---|-----------------|--------|----------|
| STANDARD |  | DOCUMENT NO. | REV.NO | PAGE |
| | | M0116LY-161LSA1 | 02 | 11 of 11 |

6. OPERATING RECOMMENDATIONS

- 6.1 Avoid applying excessive shock or vibration beyond the specification for the VFD module.
- 6.2 Since VFDs are made of glass material, careful handling is required.
- 6.3 When mounting the VFD module to your system, leave a slight gap between the VFD glass and your front panel.
The module should be mounted without stress to avoid flexing of the PCB.
- 6.4 Avoid plugging or unplugging the interface connection with the power on, otherwise it may cause the severe damage to input circuitry.
- 6.5 Slow starting power supply may cause non-operation because one chip Micom won't be reset.
- 6.6 Exceeding any of maximum ratings may cause the permanent damage.
- 6.7 Since the VFD module contain high voltage source, careful handling is required while power is on.
- 6.8 When the power is turned off, the capacitor does not discharge immediately.
So the high voltage applied to the VFD must not get in contact with ICs.
In other word, short-circuit of mounted components on PCB within 30 seconds after power-off may cause damage the module.
- 6.9 The power supply must be capable of providing at least 3 time the rated current, because the surge current may be 3 times the specified current consumption when the power is turned on.
- 6.10 Avoid using the module where excessive noise interference is expected.
Noise may affects the interface signal and causes improper operation. And it is important to keep the length of the interface cable less than 50cm.
- 6.11 Since all VFD modules contain C-MOS ICs, anti-static handling procedures are always required.