

# P60A & P60AS SERIES ROTARY DIP SWITCHES

## FEATURES

- New 4 + 1 terminal layout.
- Completely sealed for process compatibility.
- Ultra-compact size with 10 or 16 positions.
- Precision designed detent action.
- Thru-hole (P60A Series) & SMT (P60AS Series) models.
- High reliability & long life.
- Clockwise or counterclockwise settable.
- Solder coated terminals.



SPECIFICATIONS SUBJECT TO CHANGE WITHOUT NOTICE.

## GENERAL SPECIFICATIONS

### ELECTRICALS

Operating voltage	24 VDC max.
Contact rating, static	400 mA max.
Contact rating, dynamic	150 mA max.
Test voltage	250V 50Hz/1 min.
Initial contact resistance	< 100 milliohms
Insulation resistance	> 100 megohms

### MECHANICALS, THERMALS

Torque	0.98 inch-oz. min. (0.7 Ncm min.)
Expected life	10,000 switching operations
Contact force	15 grams min.
Operating temperature range	-20°C to 85°C

### SOLDERING RECOMMENDATIONS

Hand soldering	340°C max. for 2 seconds max. (40 watt iron max.)
Wave soldering	260°C max. for 10 seconds max.
Reflow soldering (SMT)	215°C max. for 40 seconds max.
Solvent washing	Freons or alcohol. (Do not use chlorinated solvents)
Aqueous cleaning	Deionized water preferred

## MATERIALS

Base	UL94V-O, high temperature thermoplastic
Cover	UL94V-O, high temperature thermoplastic
Actuator	Nylon
Contacts	Gold over nickel plated stainless steel
Terminals	Solder coated copper
Terminal sealing	Molded-in
Actuator seal	'O'-ring

P

## Thru-hole and SMT Printed Circuit Models

Code (see truth tables pg. G22)	Positions	Model No. Thru-hole Mounting (see fig. 1)	Model No. Surface Mounting (see fig. 2)
Binary Coded Decimal	10	<b>P60A701</b>	<b>P60AS701</b>
Complement of BCD	10	<b>P60A702</b>	<b>P60AS702</b>
Binary Coded Hexadecimal	16	<b>P60A703</b>	<b>P60AS703</b>
Complement of BCH	16	<b>P60A706</b>	<b>P60AS706</b>

Figure 1

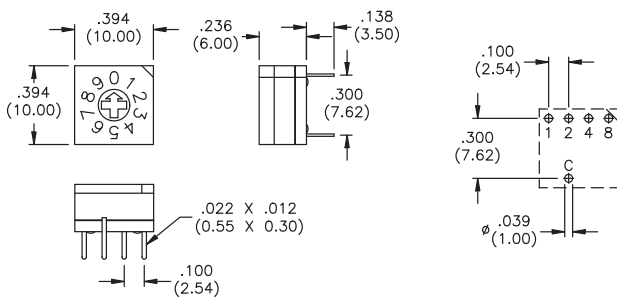

Mechanical outline

P.C. hole pattern

Figure 2

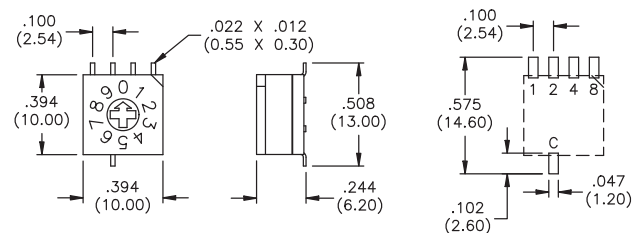

Mechanical outline

P.C. pad layout

**STANDARD OPTIONS BY SERIES:**

Series	P60A	P60AS
<b>Actuators</b>		
3 Spindle	X	X*
5 Segment wheel	X	X*
7 Cross shaped slot	X	X
<b>Codes</b>		
01 BCD	X	X
02 BCD complement	X	X
03 Hexadecimal	X	X
06 Hexadecimal Comp.	X	X

**Terminals**

None	Straight	X	
V	Crimped	X	
L508	Rt. angle 5.08 (.200")	X	
None	SMT		X

\* - Please contact factory

**ORDER GUIDE:**

Make selections from the above table in sequence to specify a complete model number.

Note that 'None' indicates that no option suffix is required.

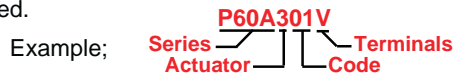

**P60A & P60AS SERIES**

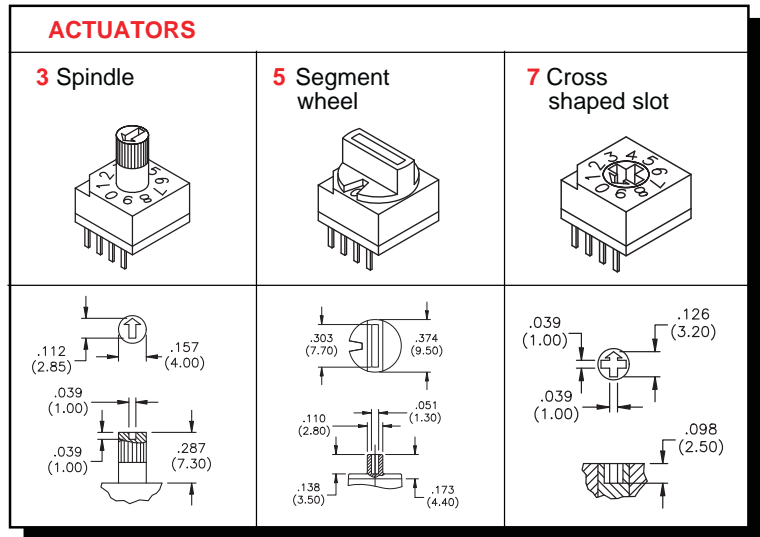

See page G19 for optional Operating Elements.

SPECIFICATIONS SUBJECT TO CHANGE WITHOUT NOTICE.

**CODES**

NOTE: For each dial position in tables, Common terminals (C) are connected to terminal number(s) indicated - i.e. - none or combinations of 1, 2, 4 or 8. Each model in this series has 2 Common terminals.

**BINARY CODED DECIMAL (01)**

10 Positions

Dial No.	1	2	4	8
0				
1	•			
2		•		
3	•	•		
4			•	
5	•		•	
6		•	•	
7	•	•	•	
8				•
9	•			•

**COMP. OF BINARY CODED DECIMAL (02)**

10 Positions

Dial No.	1	2	4	8
0	•	•	•	•
1		•	•	•
2	•		•	•
3		•		•
4	•	•		•
5		•		•
6	•			•
7	•			•
8	•	•	•	
9		•	•	

**BINARY CODED HEXADECIMAL (03)**

16 Positions

Dial No.	1	2	4	8
0				
1	•			
2		•		
3	•	•		
4			•	
5	•		•	
6		•	•	
7	•	•	•	
8				•
9	•			•
A		•		•
B	•	•		•
C			•	•
D	•		•	•
E		•	•	•
F	•	•	•	•

**COMP. OF BINARY CODED HEXADEC. (06)**

16 Positions

Dial No.	1	2	4	8
0	•	•	•	•
1		•	•	•
2	•		•	•
3		•		•
4	•	•		•
5		•		•
6	•			•
7	•			•
8	•	•	•	
9		•	•	
A	•		•	
B		•		•
C	•	•		
D		•		
E	•			
F				

**MECHANICAL OUTLINES**

**Terminal option suffix\*:**

**NONE**  
Straight terminals

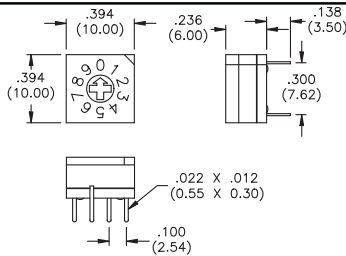

**V**  
Crimped terminals

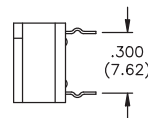

**L508**  
Right angle terminals

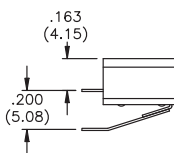

**NONE**  
SMT terminals

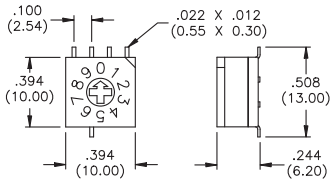

**Mtg. hole pattern:**

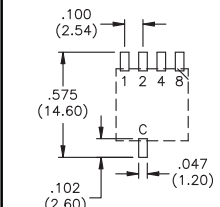
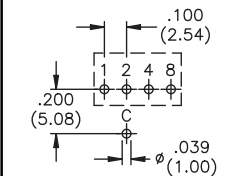
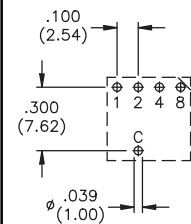

\* 'None' indicates no option suffix is required.