

# NUD4700

## LED Shunt

The NUD4700 is an electronic shunt which provides a current bypass in the case of a single LED going into open circuit. LEDs are by nature quite fragile when subjected to transients and surge conditions. There are also many cases where high reliability of the LED lighting must be maintained such as headlights, lighthouses, bridges, aircraft, runways and so forth. In these cases the low cost addition of the NUD4700 will provide full assurance that an entire string of LEDs will not extinguish should one LED fail. NUD4700 is also applicable to other loads where circuit continuity is required. This device is designed to be used with 1 W LEDs (nominally 350 mA @ 3 V).

### Features

- A Simple Two Terminal Device
- Automatically Resets Itself if the LED Heals Itself or is Replaced
- ON-State Voltage Typically 1 V
- OFF-State Current less than 250  $\mu$ A
- Available with White Package
- SZ Prefix (black package only) for Automotive and Other Applications Requiring Unique Site and Control Change Requirements; AEC-Q101 Qualified and PPAP Capable
- These Devices are Pb-Free, Halogen Free/BFR Free and are RoHS Compliant

### Typical Applications

- LEDs where Preventive Maintenance is Non Practical
- LED Headlights
- LEDs with High Reliability Requirements
- Crowbar Protection for Open Circuit Conditions
- Overvoltage Protection for Sensitive Circuits



**ON Semiconductor®**

[www.onsemi.com](http://www.onsemi.com)

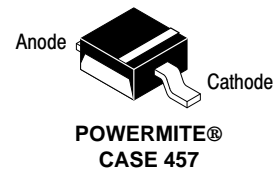
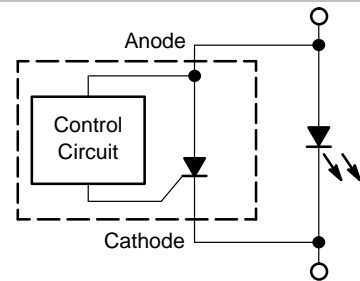

### MARKING DIAGRAM

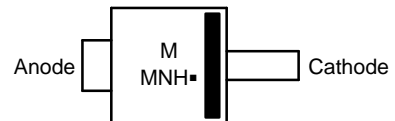

M = Date Code  
MNH = Device Code  
▪ = Pb-Free Package

### PIN FUNCTION DESCRIPTION

Pin	Description
Anode	Positive Input Voltage to the Device
Cathode	Negative Input Voltage to the Device

### ORDERING INFORMATION

Device	Package	Shipping†
NUD4700SNT1G	POWERMITE (Black)	3000/Tape & Reel
SZNUD4700SNT1G	POWERMITE (Black)	3000/Tape & Reel
NUD4700WSNT1G	POWERMITE (White)	3000/Tape & Reel

†For information on tape and reel specifications, including part orientation and tape sizes, please refer to our Tape and Reel Packaging Specifications Brochure, BRD8011/D.

# NUD4700

**MAXIMUM RATINGS** (Maximum ratings are those, that, if exceeded, may cause damage to the device. Electrical Characteristics are not guaranteed over this range)

Rating	Symbol	Value	Unit
Peak Repetitive Off State Voltage (Anode to Cathode)	$V_{DM}$	-0.3 to 10	V
Average On-State Current, ( $T_A = 25^\circ\text{C}$ ), (Note 1) (Note 2)	$I_{T(AVG)}$	1.3 0.376	A
Thermal Resistance, Junction-to-Air (Note 1) (Note 2)	$Q_{JA}$	80 277	$^\circ\text{C/W}$
Thermal Resistance, Junction-to-Lead	$Q_{JL}$	35	$^\circ\text{C/W}$
Power Dissipation ( $T_A = 25^\circ\text{C}$ ) (Note 1) (Note 2)	$P_{MAX}$	1.56 0.45	W
Operating Temperature Range	$T_J$	-40 to 150	$^\circ\text{C}$
Non-Operating Temperature Range	$T_J$	150	$^\circ\text{C}$
Lead Temperature, Soldering (10 Sec)	$T_L$	260	$^\circ\text{C}$

Stresses exceeding those listed in the Maximum Ratings table may damage the device. If any of these limits are exceeded, device functionality should not be assumed, damage may occur and reliability may be affected.

1. Mounted onto a 1" x 1" square copper pad.

Normally this device would be mounted on the same copper heat sink and adjacent to the LED. If the LED were to go open, then the NUD4700 shunt would now dissipate the power using the same copper heat sink. Since the NUD4700 has a voltage that is nominally 30% of the LED, then the power dissipation would be easily handled by the same heat sink as the LED.

2. Device mounted on minimum copper pad.

## ELECTRICAL CHARACTERISTICS (Unless otherwise noted: $T_A = 25^\circ\text{C}$ )

Characteristics	Symbol	Min	Typ	Max	Unit
Off-State Current ( $V_{Anode} = 5\text{ V}$ )	$I_{LEAK}$	-	100	250	$\mu\text{A}$
Breakdown Voltage ( $I_{BR} = 1\text{ mA}$ )	$V_{(BR)}$	5.5	-	7.5	V
Holding Current ( $V_{Anode} = 10\text{ V}$ , $I_{initial} = 100\text{ mA}$ )	$I_H$	-	6.0	12	mA
Latching Current ( $V_{Anode} = 10\text{ V}$ )	$I_L$	-	35	70	mA
On-State Voltage ( $I_T = 0.350\text{ A}$ ) ( $I_T = 0.750\text{ A}$ ) ( $I_T = 1.0\text{ A}$ )	$V_T$	- - -	1.0 1.0 1.0	1.2 - -	V

## DYNAMIC CHARACTERISTICS

Critical Rate-of-Rise of Off State Voltage ( $V_{pk} = \text{Rated } V_{(BR)}$ , $T_J = 125^\circ\text{C}$ , Exponential Method)	$dV/dt$	250	-	-	$\text{V}/\mu\text{s}$
---	---------	-----	---	---	------------------------

Product parametric performance is indicated in the Electrical Characteristics for the listed test conditions, unless otherwise noted. Product performance may not be indicated by the Electrical Characteristics if operated under different conditions.

# NUD4700

## TYPICAL PERFORMANCE CURVES

( $T_A = 25^\circ\text{C}$  unless otherwise noted)

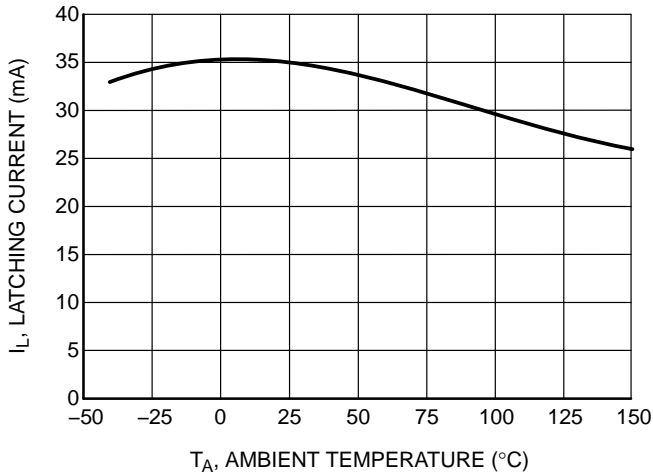

**Figure 1. Latching Current vs Temperature**

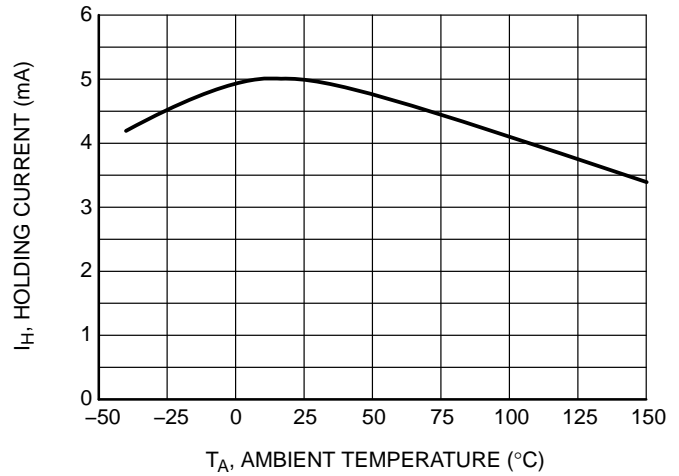

**Figure 2. Holding Current vs Temperature**

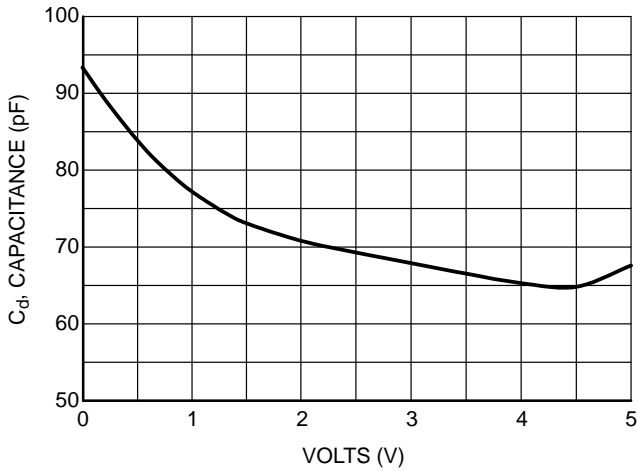

**Figure 3. Capacitance vs Voltage**

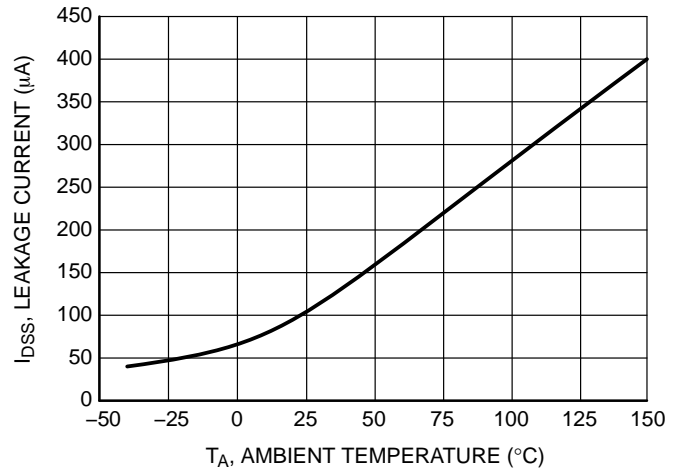

**Figure 4. Leakage Current vs Temperature**

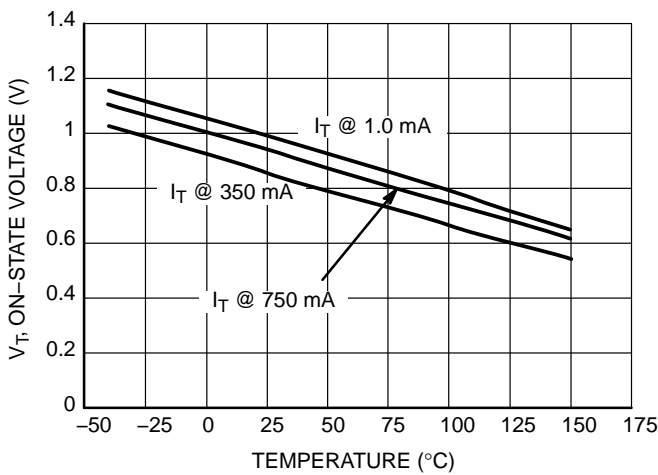

**Figure 5. On-State Voltage vs. Temperature**

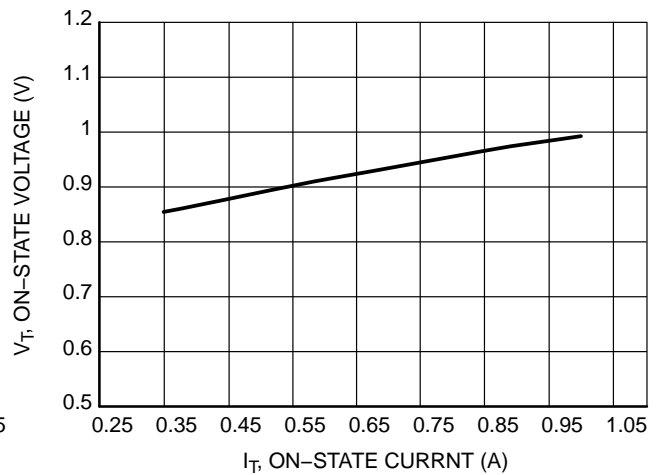

**Figure 6. On-State Voltage vs. On-State Current ( $I_T$ ) at  $25^\circ\text{C}$**

# NUD4700

## TYPICAL APPLICATION CIRCUIT

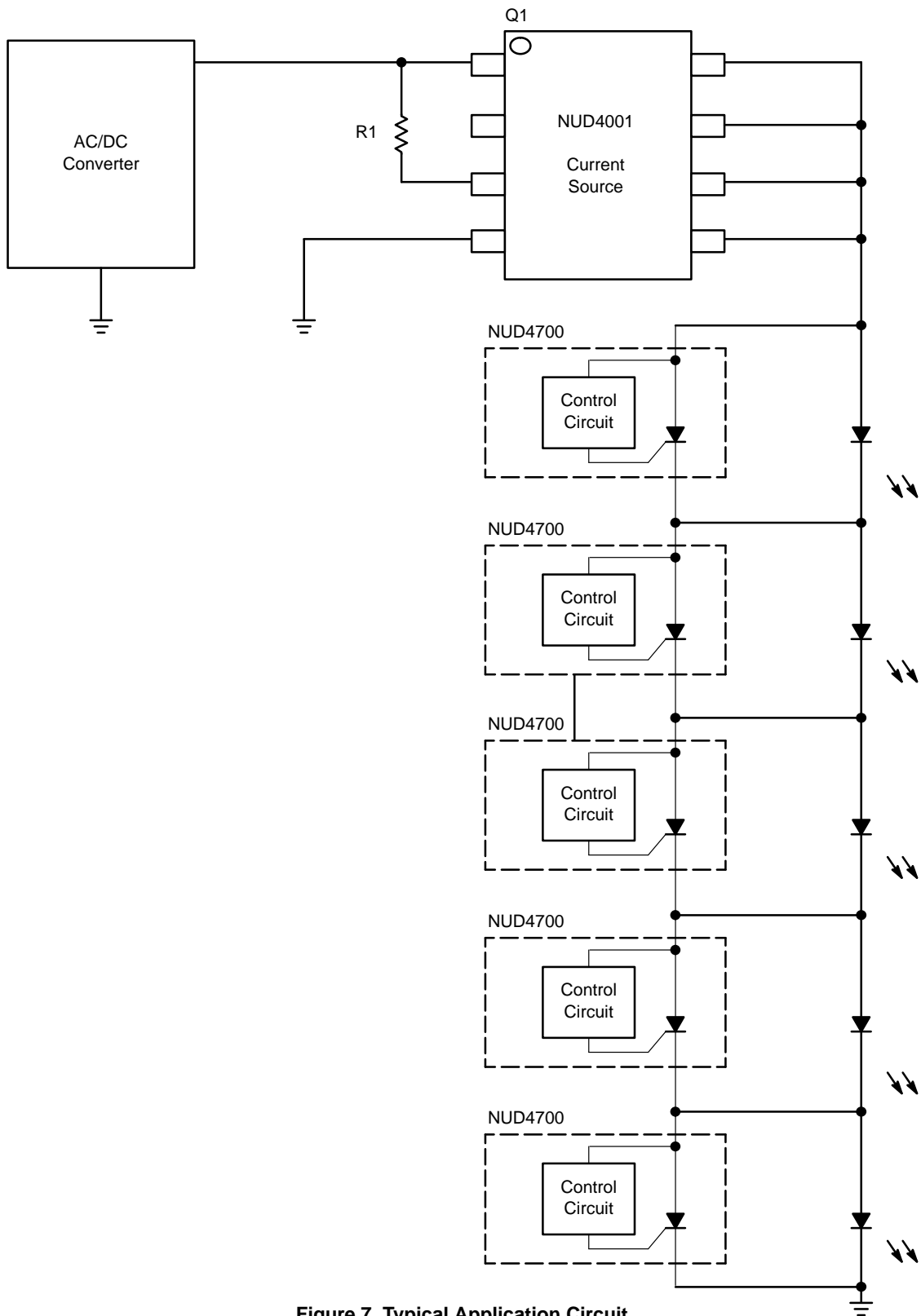

Figure 7. Typical Application Circuit

# NUD4700

## TYPICAL OPERATION WAVEFORMS

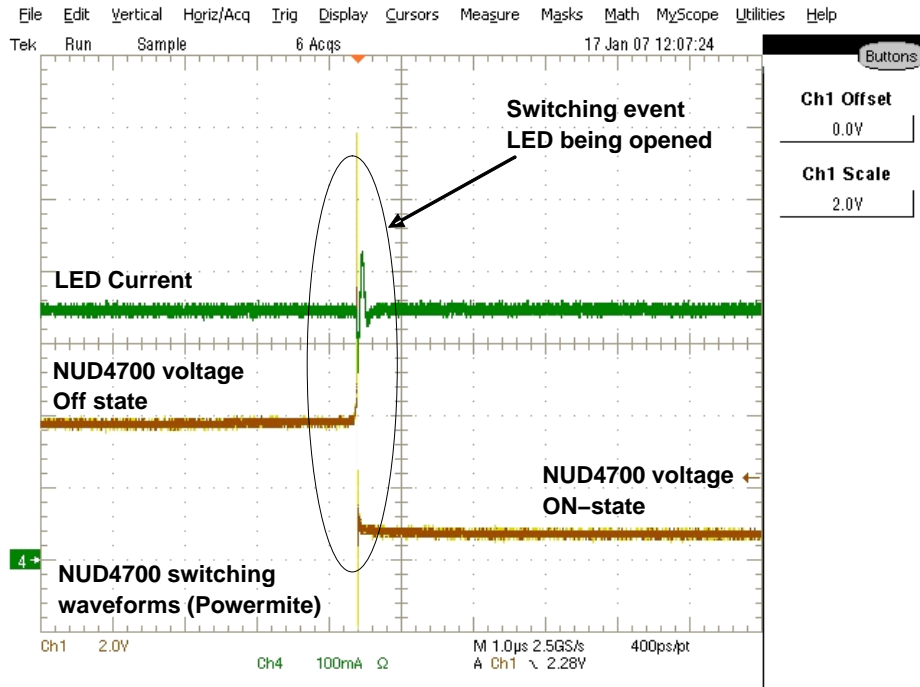

Figure 8. NUD4700 Switching Waveforms

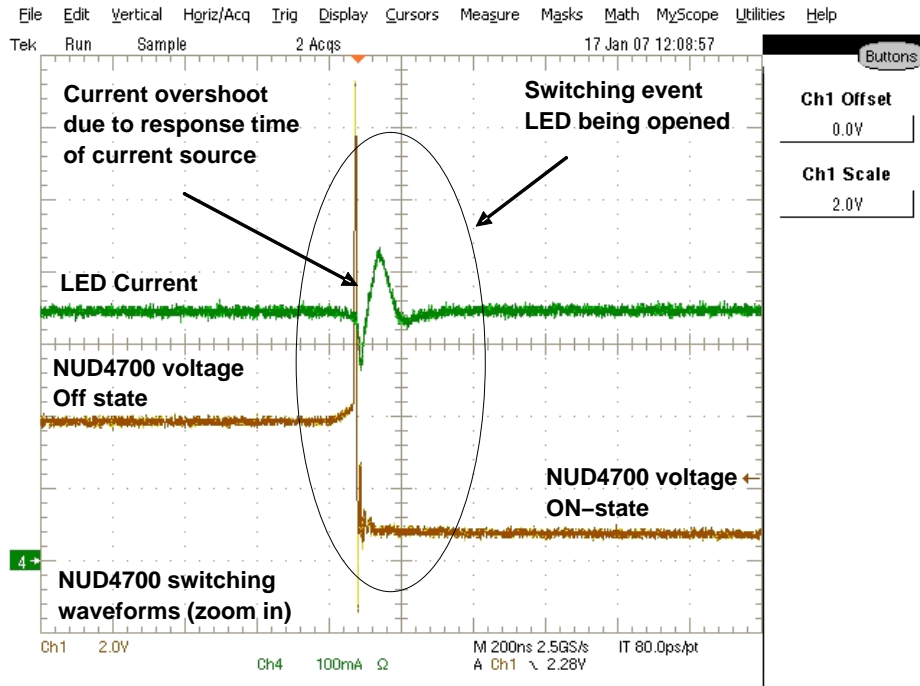
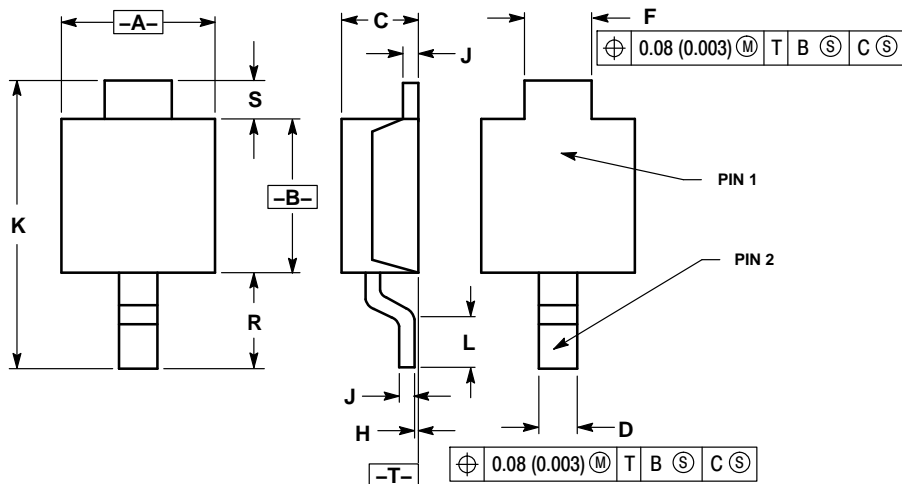

Figure 9. Zoom in of Figure 8

# NUD4700

## PACKAGE DIMENSIONS

### POWERMITE CASE 457-04 ISSUE F



#### NOTES:

1. DIMENSIONING AND TOLERANCING PER ANSI Y14.5M, 1982.
2. CONTROLLING DIMENSION: MILLIMETER.
3. DIMENSIONS A AND B DO NOT INCLUDE MOLD FLASH, PROTRUSIONS OR GATE BURRS. MOLD FLASH, PROTRUSIONS OR GATE BURRS SHALL NOT EXCEED 0.15 (0.006) PER SIDE.

DIM	MILLIMETERS		INCHES	
	MIN	MAX	MIN	MAX
A	1.75	2.05	0.069	0.081
B	1.75	2.18	0.069	0.086
C	0.85	1.15	0.033	0.045
D	0.40	0.69	0.016	0.027
F	0.70	1.00	0.028	0.039
H	-0.05	+0.10	-0.002	+0.004
J	0.10	0.25	0.004	0.010
K	3.60	3.90	0.142	0.154
L	0.50	0.80	0.020	0.031
R	1.20	1.50	0.047	0.059
S	0.50 REF		0.019 REF	

#### SOLDERING FOOTPRINT\*

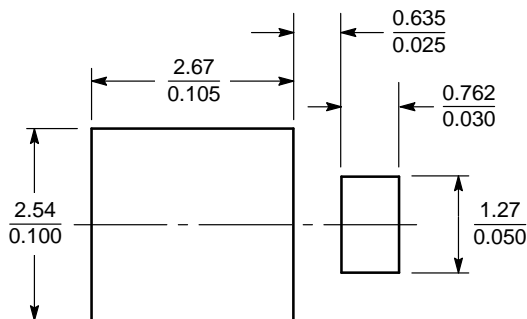

SCALE 10:1 ( $\frac{\text{mm}}{\text{inches}}$ )

\*For additional information on our Pb-Free strategy and soldering details, please download the ON Semiconductor Soldering and Mounting Techniques Reference Manual, SOLDERRM/D.

POWERMITE is a registered trademark of and used under a license from Microsemi Corporation.

ON Semiconductor and are trademarks of Semiconductor Components Industries, LLC dba ON Semiconductor or its subsidiaries in the United States and/or other countries. ON Semiconductor owns the rights to a number of patents, trademarks, copyrights, trade secrets, and other intellectual property. A listing of ON Semiconductor's product/patent coverage may be accessed at [www.onsemi.com/site/pdf/Patent-Marking.pdf](http://www.onsemi.com/site/pdf/Patent-Marking.pdf). ON Semiconductor reserves the right to make changes without further notice to any products herein. ON Semiconductor makes no warranty, representation or guarantee regarding the suitability of its products for any particular purpose, nor does ON Semiconductor assume any liability arising out of the application or use of any product or circuit, and specifically disclaims any and all liability, including without limitation special, consequential or incidental damages. Buyer is responsible for its products and applications using ON Semiconductor products, including compliance with all laws, regulations and safety requirements or standards, regardless of any support or applications information provided by ON Semiconductor. "Typical" parameters which may be provided in ON Semiconductor data sheets and/or specifications can and do vary in different applications and actual performance may vary over time. All operating parameters, including "Typicals" must be validated for each customer application by customer's technical experts. ON Semiconductor does not convey any license under its patent rights nor the rights of others. ON Semiconductor products are not designed, intended, or authorized for use as a critical component in life support systems or any FDA Class 3 medical devices or medical devices with a same or similar classification in a foreign jurisdiction or any devices intended for implantation in the human body. Should Buyer purchase or use ON Semiconductor products for any such unintended or unauthorized application, Buyer shall indemnify and hold ON Semiconductor and its officers, employees, subsidiaries, affiliates, and distributors harmless against all claims, costs, damages, and expenses, and reasonable attorney fees arising out of, directly or indirectly, any claim of personal injury or death associated with such unintended or unauthorized use, even if such claim alleges that ON Semiconductor was negligent regarding the design or manufacture of the part. ON Semiconductor is an Equal Opportunity/Affirmative Action Employer. This literature is subject to all applicable copyright laws and is not for resale in any manner.

#### PUBLICATION ORDERING INFORMATION

##### LITERATURE FULFILLMENT:

Literature Distribution Center for ON Semiconductor  
19521 E. 32nd Pkwy, Aurora, Colorado 80011 USA  
Phone: 303-675-2175 or 800-344-3860 Toll Free USA/Canada  
Fax: 303-675-2176 or 800-344-3867 Toll Free USA/Canada  
Email: [orderlit@onsemi.com](mailto:orderlit@onsemi.com)

N. American Technical Support: 800-282-9855 Toll Free  
USA/Canada  
Europe, Middle East and Africa Technical Support:  
Phone: 421 33 790 2910  
Japan Customer Focus Center  
Phone: 81-3-5817-1050

ON Semiconductor Website: [www.onsemi.com](http://www.onsemi.com)

Order Literature: <http://www.onsemi.com/orderlit>

For additional information, please contact your local Sales Representative