

8-Channel Power Supply System Featuring the LTC2977 PMBus Power System Manager

DESCRIPTION

The DC2028A is a demonstration system that showcases the LTC[®]2977, an 8-channel I²C/SMBus/PMBus Power System Manager with EEPROM. The LTC2977 monitors and controls eight power supply rails. The DC2028A demonstrates the ability of the LTC2977 to sequence, trim, margin, supervise, monitor, and log faults for eight power supplies. Each power supply channel's output voltage is monitored and the LTC2977 monitors its own internal die temperature.

The DC2028A is a single circuit board that contains eight independent power supply rails. The board employs eight LTC3405A 300mA switch mode regulators, which are configured to be controlled by the LTC2977. The DC2028A demo board provides a sophisticated 8-channel digitally programmable power supply system. The rail voltages are programmable within the trim range shown in Table 1.

This demonstration system is supported by the LTpowerPlay™ graphical user interface (GUI) which enables complete control of all the features of the device. Together, the LTpowerPlay software and DC2028A hardware system create a powerful development environment for designing and testing configuration settings of the LTC2977. These settings can be stored in the device's internal EEPROM or in a file. This file can later be used to order preprogrammed devices or to program devices in a production environment. The software displays all of the configuration settings and real time measurements from the Power System Management IC. Telemetry allows easy access and decoding of the fault log created by the LTC2977. The board comes preprogrammed with the EEPROM values appropriate for the eight power supply rails on the DC2028A. Just plug and play!

Multiple DC2028A boards can be cascaded together to form a high channel count power supply (see Multi-Board Arrays). This cascaded configuration demonstrates features of the LTC Power System Management ICs which enable timing and fault information to be shared across multiple Power System Management ICs. The user can configure up to eight DC2028A boards, thereby controlling up to 64 separate power supply rails. Larger board arrays

can be built using programmable I²C base addresses or bus segmentation.

The DC2028A demo board can be powered by an external power supply, such as a 12VDC supply. Communication with the software is provided through the DC1613 USB-to-I²C/SMBus/PMBus controller. The following is a checklist of items which can be obtained from the LTC website or LTC Field Sales.

- USB-to-I²C/SMBus/PMBus Controller (DC1613)
- LTpowerPlay Software

Design files for this circuit board are available at <http://www.linear.com/demo>

DC2028A FEATURES

- Sequence, Trim, Margin, and Supervise Eight Power Supplies
- Manage Faults, Monitor Telemetry, and Create Fault Logs
- PMBus Compliant Command Set
- Supported by LTpowerPlay GUI
- Margin or Trim Supplies to 0.25% Accuracy
- Fast OV/UV Supervisors per Channel
- Supports Multichannel Fault Management
- Automatic Fault Logging to Internal EEPROM
- Operates Autonomously without Additional SW
- Eight OV/UV V_{OUT} and One V_{IN} Supervisor
- Telemetry Reads Back V_{IN}, V_{OUT}, and Temperature
- 8-Channel Time-Based Output Sequencer
- I²C/SMBus Serial Interface
- Powered from 6V to 14V
- LTC2977 Available in 64-Lead QFN Package

LT, LT, LTC, LTM, Linear Technology, and the Linear logo are registered trademarks and LTpowerPlay is a trademark of Linear Technology Corporation. All other trademarks are the property of their respective owners. Protected by U.S. Patents including 7382303, 7420359 and 7940091.

dc2028af

PERFORMANCE SUMMARY Specifications are at T_A = 25°C

POWER SUPPLY CHANNEL	CH(0:7)
Manager/Controller	LTC2977
Nominal Untrimmed Output Voltages	1.2V, 1.5V, 1.8V, 2.0V, 2.5V, 2.7V, 3.0V, 3.3V
Rated Output Current	0.3A
Default Margin Range	±5%
Output Trim Range (V _{FS_VDAC} = 1.38V)	+15%/-11%
Temperature	1 Internal

Common Characteristics Specifications Valid Over Full Operating Temperature Range

PARAMETER	CONDITIONS	MIN	TYP	MAX	UNITS
Supply Input Voltage Range		6		14	V
ADC Total Unadjusted Error	V _{IN_ADC} ≥ 1V			±0.25	%
ADC Voltage Sensing Input Range	Differential Voltage: V _{IN_ADC} = (V _{SENSEp[n]} - V _{SENSEm[n]})	0		6	V

GLOSSARY OF TERMS

The following list contain terms used throughout the document.

Channel – The collection of functions that monitor, supervise, and trim a given power supply rail.

EEPROM – Non-volatile memory (NVM) storage used to retain data after power is removed.

Margin – Term used typically in board level testing that increases/decreases the output voltage to look for sensitivity/marginality problems.

Monitor – The act of measuring voltage, current, and temperature readings.

NVM – Non-volatile memory, see EEPROM.

PMBus – An industry standard power management protocol with a fully defined command language that facilitates communication with power converters and other devices in a power system.

Rail – The final output voltage that the power supply controller manages.

Supervise – The act of quickly responding to a voltage, current, temperature condition that is compared to pre-programmed values (fault settings).

Trim – The act of adjusting the final output voltage. A servo loop is typically used to trim the voltage.

LTpowerPlay GUI SOFTWARE

LTpowerPlay is a powerful Windows based development environment that supports Linear Technology power system management ICs with EEPROM, including the LTC2977 8-channel PMBus Power System Manager. The software supports a variety of different tasks. You can use LTpowerPlay to evaluate Linear Technology ICs by connecting to a demo board system. LTpowerPlay can also be used in an offline mode (with no hardware present) in order to build a multi-chip configuration file that can be saved and reloaded at a later time. LTpowerPlay provides unprecedented system level diagnostic and debug features. It becomes a valuable diagnostic tool during board bring up to program or tweak the power management scheme

in a system or to diagnose power issues when bringing up rails. LTpowerPlay utilizes the DC1613 I²C/SMBus/PMBus controller to communicate with one of many potential targets, including the DC2028A demo system or a customer board. The software also provides an automatic update feature to keep the software current with the latest set of device drivers and documentation. The LTpowerPlay software can be downloaded from:

<http://www.linear.com/ltpowerplay>

To access technical support documents for LTC Power System Management Products visit Help, View Online Help on the LTpowerPlay menu.

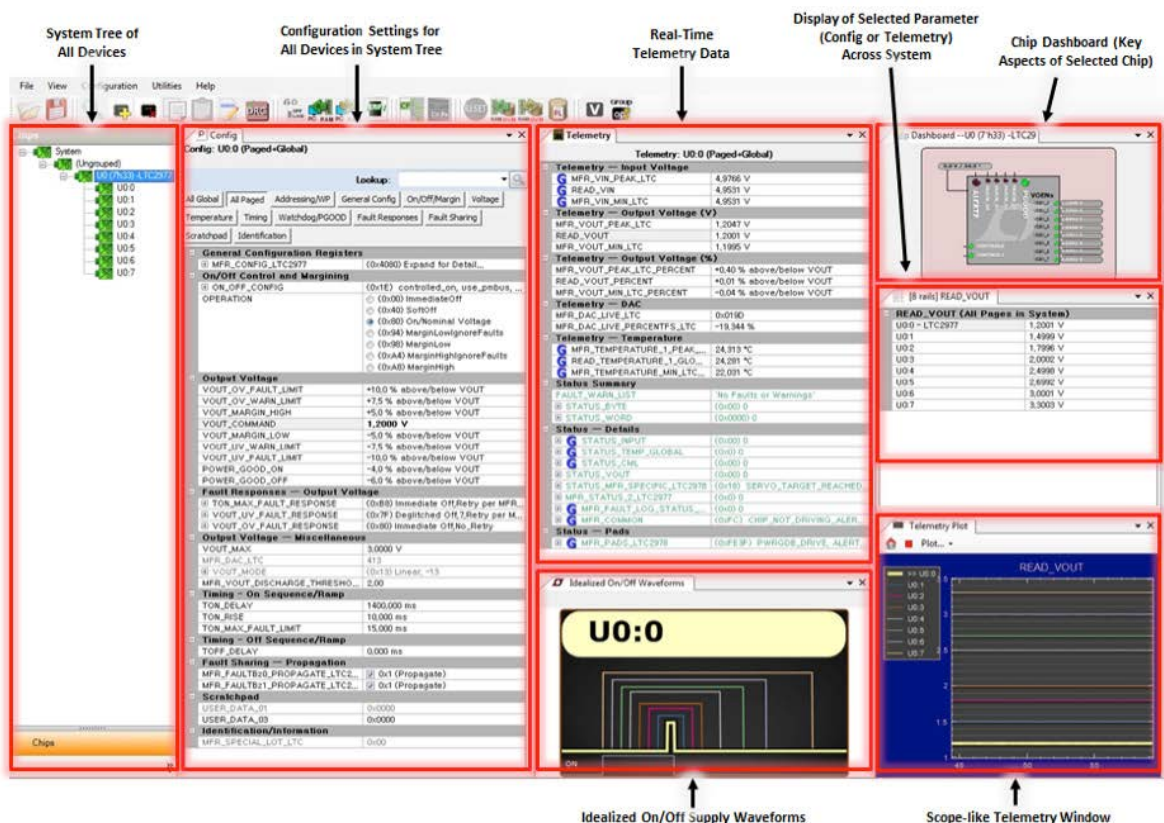

Figure 1. Screenshot of the LTpowerPlay GUI

QUICK START PROCEDURE

The following procedure describes how to set up a DC2028A demo system.

1. Download and install the LTpowerPlay GUI: www.linear.com/ltpowerplay
2. Remove the board from the ESD protective bag and place it on a level surface. Connect the DC1613 I²C/SMBus/PMBus controller to the DC2028A board using the 12-pin ribbon cable.



Figure 2. Connecting DC2028A Board and the DC1613 I²C/SMBus/PMBus Controller

3. Confirm that the CONTROL switch is set to the RUN position.
4. Plug the USB-to-I²C/SMBus/PMBus controller into a USB port on your PC. The board should power-up with all power good LEDs and 5V LED illuminated green. The USB-to-I²C/SMBus/PMBus controller supplies ~100mA of current which should be sufficient for a single demo board.
5. If multiple boards are being powered, connect a 12VDC power supply with > 0.5A capacity to the V_{IN} input jack of the DC2028A.
6. Launch the LTpowerPlay GUI.
 - a. The GUI automatically identifies the DC2028A and builds a system tree for each power manager. The system tree on the left hand side will look like this:

Note: For multiple board arrays, the GUI automatically ensures each device has a unique address. In this scenario, it is recommended at this point to store these addresses to NVM (EEPROM) by clicking the RAM to NVM icon in the toolbar.

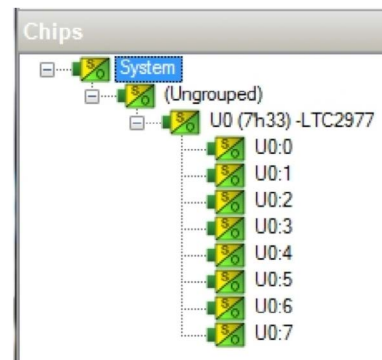

uc2u26a1

QUICK START PROCEDURE

- b. A green message box will be displayed momentarily in the lower left hand corner confirming that the DC2028A is communicating.

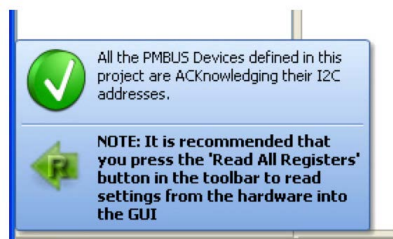

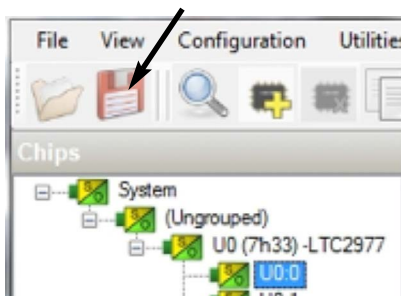

- c. Save the demo board configuration to a (*.proj) file by clicking the Save icon. This creates a backup file. Name it whatever you want.



7. The CONTROL switch is configured to control all eight channels. Slide the switch to RUN to enable, OFF to disable all channels. For multiple board arrays, the CONTROL switch is wired to a signal that is common across all boards. All CONTROL switches must be set to the RUN position to enable all boards.

LOADING A DC2028A CONFIGURATION (*.proj) FILE WITH THE GUI

1. In the upper left hand corner of the GUI, File > Open > browse to your *.proj file. This will load the file into the GUI.
2. Click on the Go Online  icon, then click on the PC->RAM icon.  This loads the configuration into the working RAM of the LTC2977.
3. To store the configuration to NVM (EEPROM), click on the RAM->NVM icon. 

DEMO MANUAL DC2028A

DC2028A DETAILS – TOP SIDE

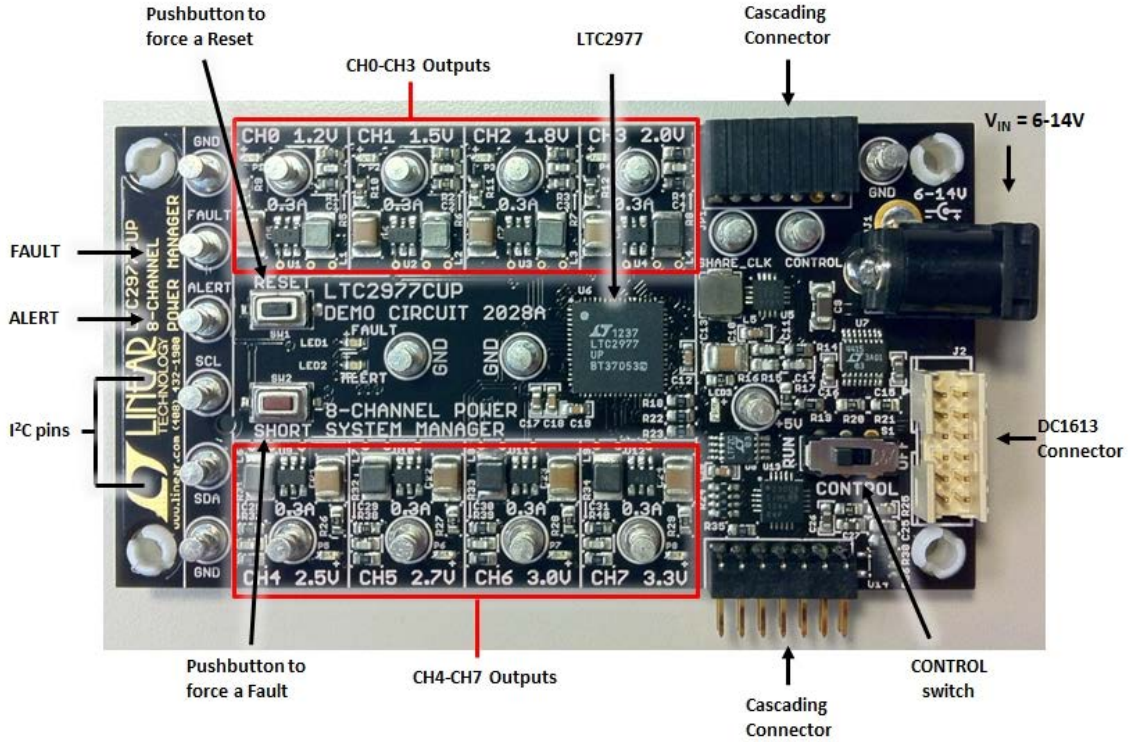
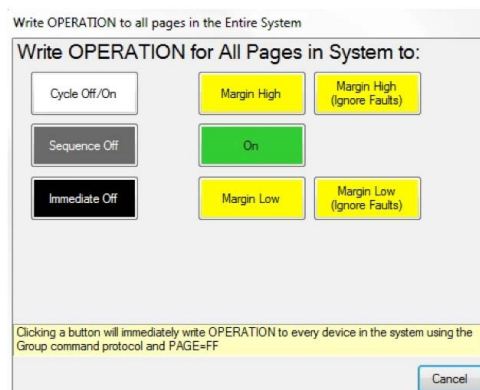

Figure 3. DC2028A Top Side Details

COMMON DEMO BOARD OPERATIONS

MARGIN ALL RAILS

The LTC2977 Power System Manager on the DC2028A not only monitors each of the eight outputs but can margin the outputs either high or low. Margining is the operation that moves a rail either up or down for testing purposes. It allows a system to be fully characterized over supply limits without the use of external hardware or resources. The GUI provides an easy way to margin all rails high or all low by clicking one of four buttons. To invoke the margining dialog, click the GroupOp icon in the toolbar. The buttons labeled ignore faults will margin without creating a fault even if the fault limits are exceeded.



A look at the telemetry window shows the effect of the margin high or margin low operation. The screen shot shows all rails going from nominal setpoints to margin high, margin low, and back to nominal voltages.

The LTC2977 has a multiplexed ADC that is used to provide voltage, current, and temperature readback values. The telemetry plot in the GUI is similar to a multi-channel oscilloscope which is capable of displaying any parameter that is displayed in the telemetry window. Due to the nature of a multiplexed ADC converter, it has an associated ADC loop time. The total ADC loop time (~100-160ms) for a given channel is dependent on the device's configuration.

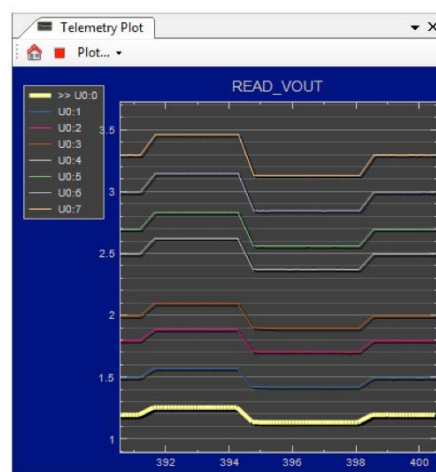

CREATING A FAULT

There is a pushbutton on the DC2028A board that is used to force a fault and demonstrate the demo board's ability to detect it and respond according to the configuration. When depressed, the pushbutton creates a fault (short to ground) on channel 7, the 3.3V output (GUI channel U0:7). The user should see all outputs power off, the fault LED momentarily illuminate, the alert LED illuminate continuously, and all rails sequence back on after a retry period. The user may also short any power supply output indefinitely. This is a good way to induce UV faults and shows that a shorted channel will not be damaged. Use a jumper wire or a coin to short any output.

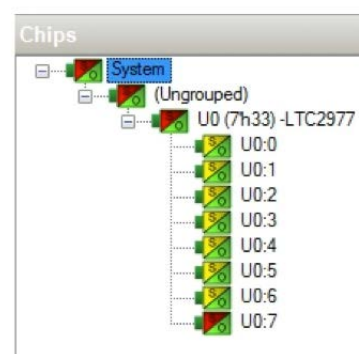

COMMON DEMO BOARD OPERATIONS

The LTC2977 has a feature which allows supply rails to sequence off in a controlled manner in response to a fault condition, as opposed to turning all rails off immediately. The SequenceOffOnFault bit in the MFR_CONFIG_LTC2977 register sets this behavior on each channel. The DC2028A demo board has been configured to sequence off all channels when a fault occurs. Pressing the SHORT pushbutton causes the Fault pin to be asserted low which triggers all rails to power down based on the TOFF_DELAY times.

General Configuration Registers	
MFR_CONFIG_LTC2977	(0x4080) Expand for Detail...
TrackingSlave	<input type="checkbox"/> False
SequenceOffOnFault	<input checked="" type="checkbox"/> True
RESERVED13	<input type="checkbox"/> 0x0
RESERVED12	<input type="checkbox"/> 0x0
fast_servo_off	<input type="checkbox"/> 0x0 (fast-servo enabled)
supervisor_resolution	<input type="checkbox"/> 0x0 (Supervisor is HI-RES)
adc_hires	<input type="checkbox"/> 0x0 (ADC is LO-RES)
controln_sel	<input type="checkbox"/> 0x0 (Control0 is Selected)
servo_continuous	<input checked="" type="checkbox"/> 0x1 (Continuously servo VOUT t...
servo_on_warn	<input type="checkbox"/> 0x0 (Do NOT allow the unit to re-...
dac_mode	<input checked="" type="checkbox"/> 0x0 (DAC Soft Connect)

Figure 4 shows FAULTB asserting low, and each of the channels sequencing off per the TOFF_DELAY settings. Figure 5 shows the same except that the 3.0V rail (CH4) does not have its SequenceOffOnFault bit set. The 3.0V rail powers down immediately as defined by the fault response setting.

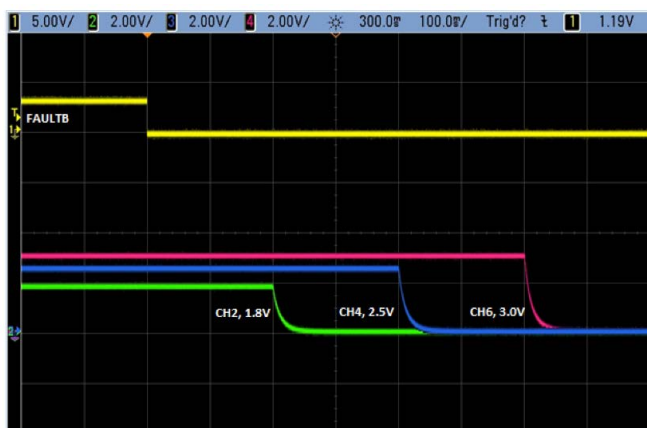

Figure 4. Sequencing Off (SeqOffOnFault=1)



Figure 5. Sequencing Off (SeqOffOnFault=0)

CLEARING A FAULT



To clear a fault, the user may click the CF icon in the GUI or simply push the RESET pushbutton on the demo board. In both cases, the red (+) on the CF icon and alert LED on the board will be cleared. You will notice that all rails are automatically re-enabled after a programmable retry period. The alert LED may be cleared by clicking the clear faults (CF) icon in the GUI. After clearing faults, the system tree may remain yellow if any non-volatile fault logs are present. For further information, see the Working with the Fault Log section.

RESETTING THE DC2028A

A reset pushbutton is provided on the board. To reset all devices on the DC2028A board and reload the EEPROM contents into operating memory (RAM), press RESET (SW2) on the DC2028A.

COMMON DEMO BOARD OPERATIONS

DC2028A LEDS

Each individual channel on DC2028A has its own green power good LED (CH0 through CH7). When USB power (DC1613 controller) or external power (6V to 14V jack) is applied, the 5V green LED will illuminate, indicating that the LTC2977 Power System Manager is powered. The red LEDs will illuminate when an alert or a fault has occurred.

SEQUENCING OUTPUT CHANNELS

The LTC2977 has been preconfigured with different TON_DELAY values for each channel. The TON_DELAY parameter is applied to each device relative to the respective CONTROL pin. When multiple demo boards are connected together, all CONTROL pins are wire OR'd. Therefore the TON delays are enforced relative to one edge. The same applies to TOFF_DELAY values. When the CONTROL switch is set to the OFF position, all rails will power down sequentially based on each of the device's TOFF_DELAY values. Figure 6 shows an oscilloscope screen capture of three output rails sequencing up and down in response to the CONTROL pin.

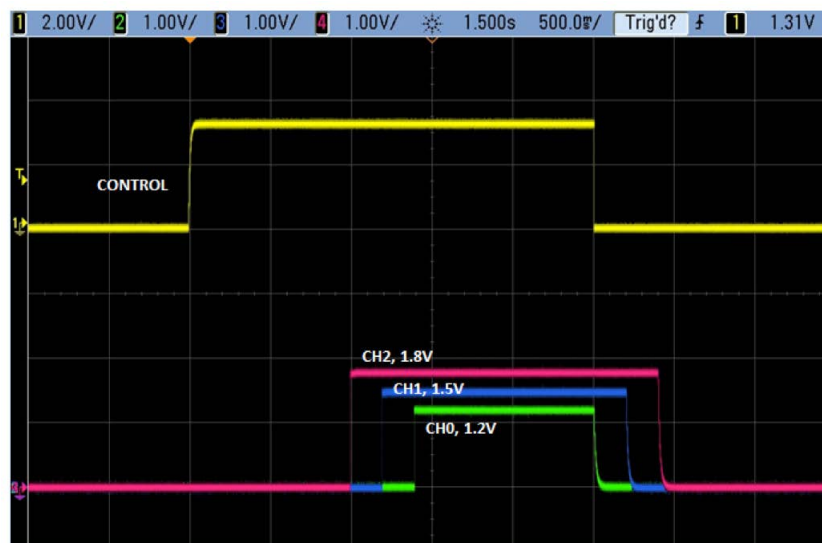

Figure 6. Sequencing Output Channels with DC2028A Using TON_DELAY and TOFF_DELAY

COMMON DEMO BOARD OPERATIONS

Each channel has an LED which visually indicates if the channel has power. When the CONTROL pin is switched on and off, you will observe the relative on/off timing of the eight channels.

Channel	Delay Time
U0:0 - LTC2977	1400,000 ms
U0:1	1200,000 ms
U0:2	1000,000 ms
U0:3	800,000 ms
U0:4	600,000 ms
U0:5	400,000 ms
U0:6	200,000 ms
U0:7	0,000 ms

Figure 7. TON_DELAY Configuration

Channel	Delay Time
U0:0 - LTC2977	0,000 ms
U0:1	100,000 ms
U0:2	200,000 ms
U0:3	300,000 ms
U0:4	400,000 ms
U0:5	500,000 ms
U0:6	600,000 ms
U0:7	700,000 ms

Figure 8. TOFF_DELAY Configuration

For the LTC2977, the TON_DELAY and TOFF_DELAY values extend to 13.1 seconds, providing very long sequencing on and off of power supply rails.

WHY AM I OFF? TOOL

Use the Why am I Off? tool in the LTpowerPlay GUI to diagnose the reason a power supply channel is turned off. The tool can be located in the top right corner of the GUI, above the Register Information tab. Hover your cursor over this tab to show the tool.

Why am I Off? Summary

Rail 'U0:0' is commanded off by the user.

Details:

Rail 'U0:0' is commanded off via the OPERATION command.

- The OPERATION command is presently **ImmediateOff** (0x00).
- Rail 'U0:0' is configured to respect the OPERATION command via ON_OFF_CONFIG.

NOTE: This is an early prototype of the analysis tool and it only presents a partial analysis of your configuration settings and device status. A number of other possibilities not mentioned here may be causing your output to be off. Consult the list below for further troubleshooting.

Figure 9. Why Am I Off? Tool in the LTpowerPlay GUI

ADVANCED DEMO BOARD OPERATIONS

WHAT IS A FAULT LOG?

A fault log is a non-volatile record of the power system leading up to the time of fault. It holds the most recent monitored values (uptime, voltage, current, temperature) that can be analyzed to help determine the cause of the fault. It is a powerful diagnostic feature of the LTC2977 on the DC2028A demo board.

CREATE A FAULT LOG

To create a fault log, you must create a fault, as described in the Creating A Fault section on page 7. If multiple boards are configured, select the appropriate device in the system tree by clicking on the appropriate LTC2977 chip. We will proceed to work with the fault log.

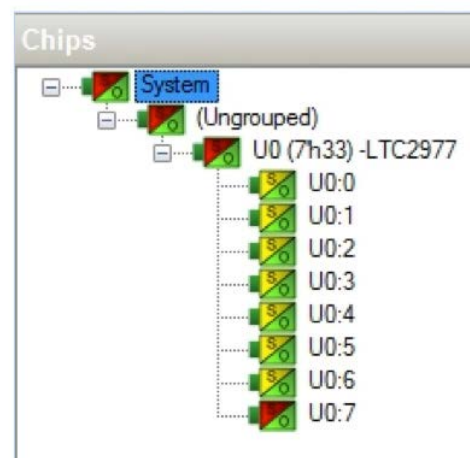

WORKING WITH THE FAULT LOG

Once a fault has occurred, the Fault Log (FL) icon will show a red (+) sign on it, indicating that the GUI has detected a fault log in the device. Clicking the icon will bring up a dialog box. Note that it is context sensitive. If multiple DC2028A boards are connected, be sure that the desired device is selected in the system tree.



Notice that the checkbox Log to EEPROM on Fault is checked. Once a fault occurs, the device will automatically write the fault log data to EEPROM (NVM). At this point, the log is locked and will not change until it is cleared by the user. To read the EEPROM log data, first click the NVM to RAM button. At this point the RAM Log is locked and not updated even though the telemetry readings continue. Click the Read RAM Log button. The log data will appear in the text box below.

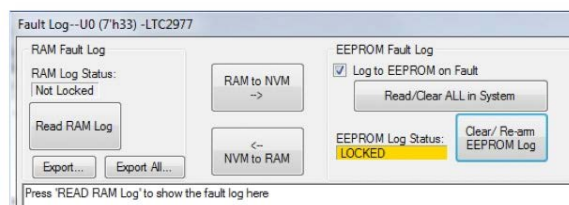

ADVANCED DEMO BOARD OPERATIONS

The log contains timestamp, up-time, channel voltage readings, an input voltage reading, an on-chip temperature reading, etc. There will be a number of loops; each loop contains data obtained in one ADC loop time with the most recent ADC loop data on top and the oldest data at the bottom of the log. The up-time indicates, at the time of fault, the amount of time the device had been powered up or time since the previous reset.

In this case, the fault log will show that channel U0:7 faulted due to a VOUT_UV_FAULT condition. On the previous telemetry loop, the channel voltage reading was a nominal value (3.3V).

To clear the fault log, click the Clear/Rearm EEPROM Log button. This allows the selected device to be ready for a new fault event. To clear all faults, click the clear faults (CF) icon.

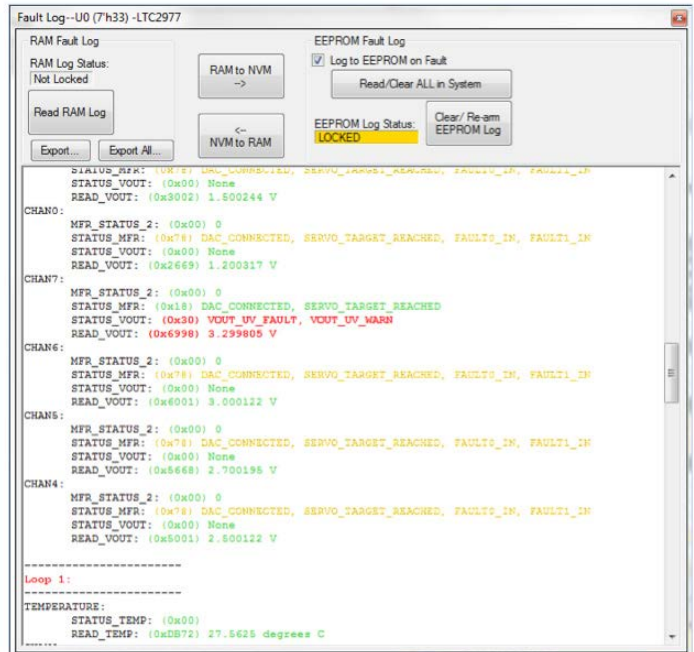

FAULT SHARING SETUP IN THE GUI

Fault sharing provides a means of propagating a fault detected by a power manager to other power managers via FAULT pins. Use the Fault Sharing Setup Tool to configure the fault sharing in the GUI. Select the LTC2977 in the system tree. Go to Utilities > Fault Sharing Diagram. For more details on this topic, please refer to the Fault Management section in the data sheet.

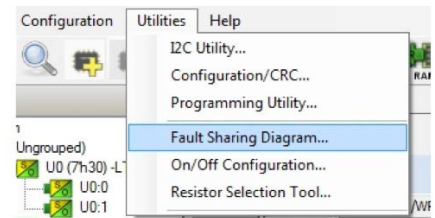

The fault sharing dialog will appear as shown in Figure 10. All response and all propagate switches are closed by default. In this configuration, a fault on a channel will shut down all LTC2977 channels, and a fault on any given channel will propagate to all channels on the DC2028A demo board since the fault pins are tied together.

NOTE: All FAULT pins of the LTC2977 are tied together on the DC2028A demo board. These pins are open drain and have a common pull-up resistor to provide a logic high level (inactive). All FAULT pins are active low.

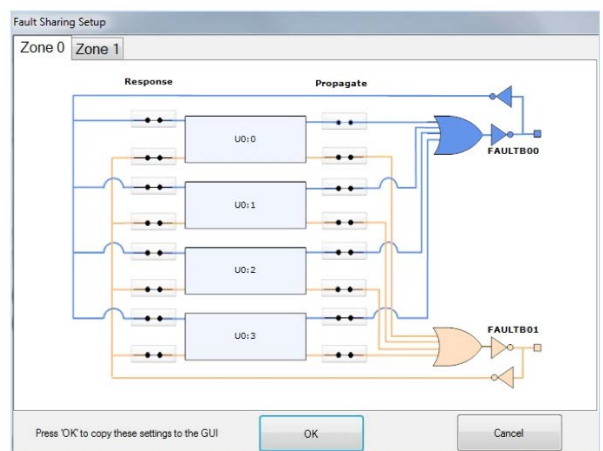



Figure 10. Fault Sharing Utility in LTpowerPlay GUI

ADVANCED DEMO BOARD OPERATIONS

There are two types of actions to fault conditions: How a channel responds to another channel's fault and whether a particular channel propagates its fault to other channels. FAULT pins are bidirectional, meaning the device may drive its fault pin low (output) or may respond to the fault pin when another device drives it low (input). Because all fault pins are wire OR'd on the DC2028A, this hardware configuration allows one to program each device's fault settings on a channel-by-channel basis. By default, the LTC2977 is configured to shut down its channels if the FAULT pin is low and to propagate its own fault via the FAULT pin. You can think of the Response switches as shut this channel down when another channel faults, and the Propagate switches as drive a fault pin to broadcast to other channels that this channel faulted.

FAULT CONFIGURATION EXAMPLE

Let's explore two different examples. Suppose we do not want channel U0:0 (CH0 1.2V rail) to propagate its fault to the other channels when it faults. And suppose we do not want channel U0:1 (CH1 1.5V rail) to shut down in response to another channel's fault. We can configure the switches as shown in Figure 11. Simply click the switches to open/close. Click  OK to close the dialog box. Click the PC->RAM icon to write the changes to the DC2028A.

We can now create a fault on U0:0 (CH0) by shorting the output to ground. You may use a coin or a jumper to temporarily connect CH0 to the GND turret. You will notice that the channel shuts off but the other channels remain powered up because its fault is not propagated to the other channels. After the retry period, channel U0:0 (CH0) will power back up. We can now observe the effect of changing the response setting on U0:1 (CH1). If you short U0:3 (CH3 2.0V rail) to ground, notice that all rails shut down except U0:1 (CH1). This is an example of a keep alive channel that remains powered up independent of faults to other channels.

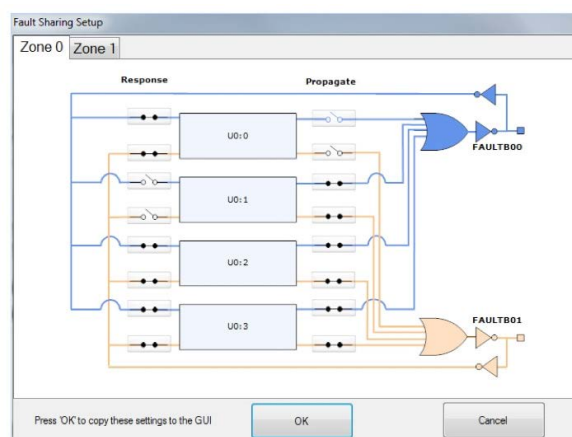

Figure 11. Updated Fault Sharing Configuration

SETUP PROCEDURE FOR MULTI-BOARD ARRAYS

Up to eight DC2028A boards can be cascaded to control up to 64 independent power supplies. The number of boards is limited by an I/O expander chip that has three address pins, allowing eight different combinations. This setup demonstrates the coordinated fault responses and accurate time base shared across multiple power system managers.

Procedure:

1. Stack the boards side-by-side by plugging JP1 of one board into JP2 of another DC2028A board.
2. Ensure different slave address settings for each of the boards. The address of each DC2028A board is set by the DIP switch JP1 on the backside of the board. The setting must be unique for each board in the array.
3. Plug the 12V V_{IN} power into one of the boards as shown in Figure 12 below. Only one 12V power source is allowed.
4. The USB-to-I²C/SMBus/PMBus controller may be plugged into any board. If no DC2028A boards show up

in the GUI, click the magnifying glass icon to enumerate the I²C bus and find the addresses of the parts. Go to step #2 to ensure that each board has a unique DIP switch setting.



5. Since the individual CONTROL lines are connected across the boards (CTRL is a common signal across all boards in the array), make sure that all CONTROL switches are set to the RUN position.
6. Relaunch LTpowerPlay. After launching, LTpowerPlay will enumerate the entire board array and build a representative system tree and read all hardware settings into the GUI.



ATTENTION: Once the GUI has launched, click the RAM->NVM button in the toolbar to ensure that the slave addresses are retained after a power off or reset. Otherwise you may lose communication with the slaves after a power cycle or reset event.



Figure 12. Array of Multiple DC2028A Demo Boards

SETUP PROCEDURE FOR MULTI-BOARD ARRAYS

ENSURING SLAVE ADDRESSES DO NOT CONFLICT

There is a small DIP switch on the backside of the DC2028A. It is used to set the slave address of an I/O expander which allows the addition of multiple boards to a setup. The I/O

expander has a base address of 0x20. The DIP switch settings set the offset. The three switches that may be changed are labeled A0, A1, A2. Examples below set the boards to addresses 0x20 and 0x27.

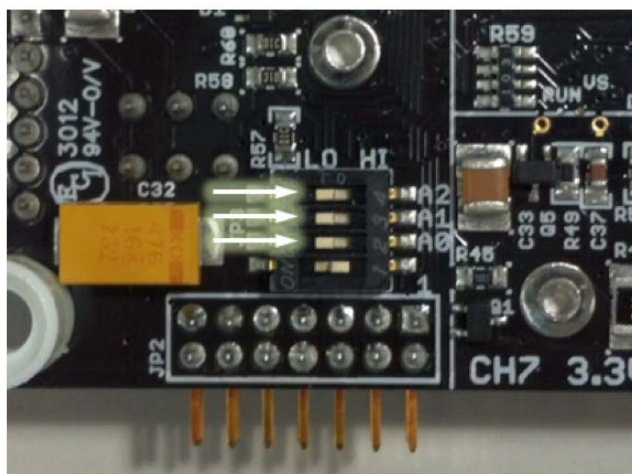

Figure 13. DIP Switch Set to All 0's (0x20)

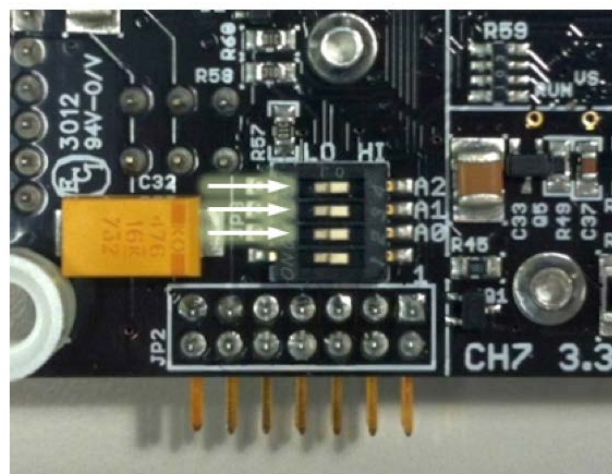

Figure 14. DIP Switch Set to All 1's (0x27)

DEMO MANUAL DC2028A

DC2028A DETAILS – TOP

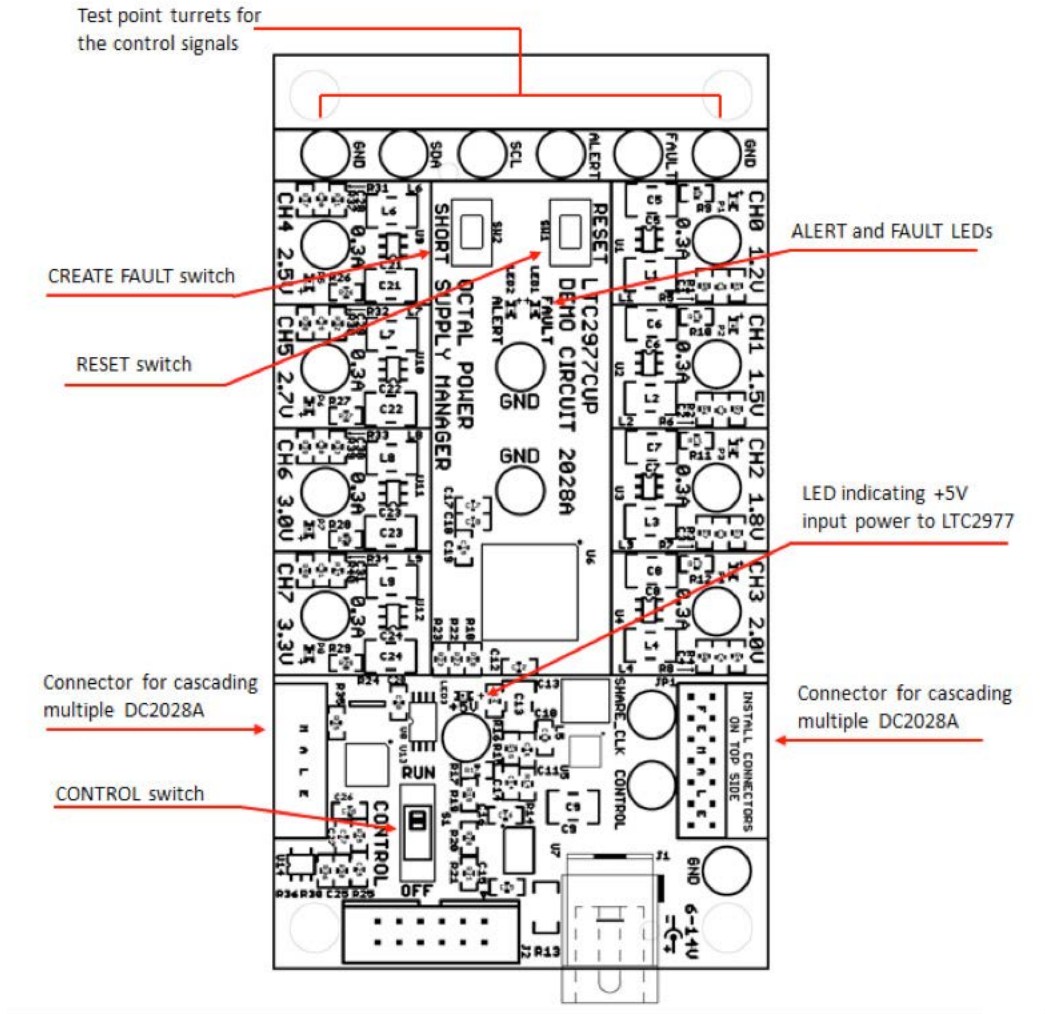
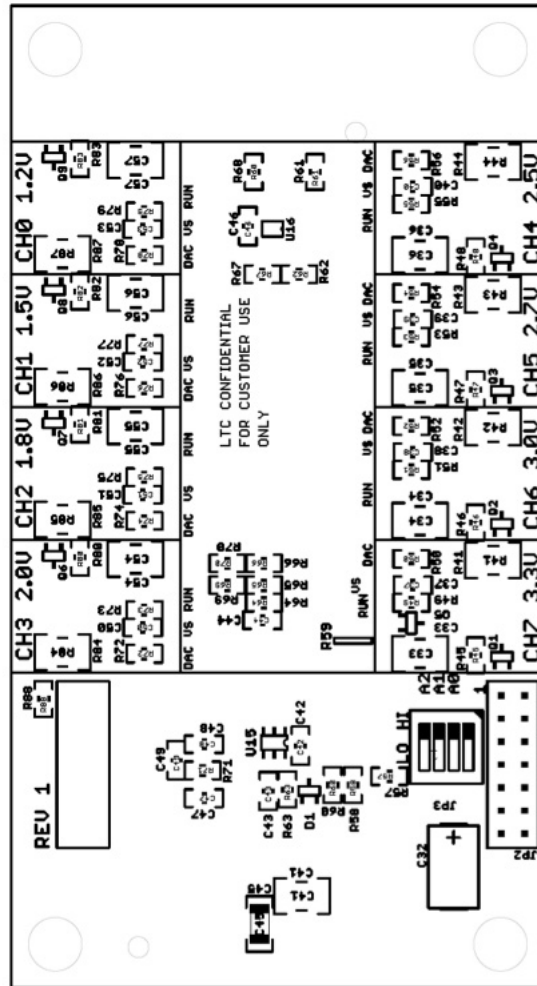

Table 1. DC2028A - Default Switch Configuration (Default Position Shown in Grey in the Figure Above)

REFERENCE DESIGNATOR	SIGNAL NAME	USAGE	DEFAULT
JP3 (Bottom)	A0, A1, A2	DIP Switch Used to Set the Address Offset	OPEN
S1	CONTROLO	Switch Used to Enable/Disable the CONTROLO Input Pin of LTC2977	RUN

DC2028A DETAILS – BOTTOM



DEMO MANUAL DC2028A

PARTS LIST

ITEM	QTY	REFERENCE	PART DESCRIPTION	MANUFACTURER/PART NUMBER
Required Circuit Components				
1	1	U6	IC 8-CH PWR SYSTEM MANAGER 64-QFN	Linear Technology: LTC2977CUP
2	3	C12, C18, C19	CAP CER 0.1 μ F 16V 10% X7R 0603	NIC: NMC0603X7R104K16TRPF
Additional Demo Board Circuit Components				
3	8	C1, C2, C3, C4, C28, C29, C30, C31	CAP CER 220pF 50V 10% NPO 0603	NIC: NMC0603NPO221J50TRPF
4	9	C5, C6, C7, C8, C21, C22, C23, C24, C41	CAP CER 10 μ F 10V 10% X5R 1210	AVX: 1210ZD106KAT2A
5	1	C9, C45	CAP CER 10 μ F 25V 20% X5R 1206	Taiyo Yuden: TMK316BJ106ML-T
6	11	C10, C20, C37, C38, C39, C40, C46, C50, C51, C52, C53	CAP CER 0.1 μ F 16V 10% X7R 0603	NIC: NMC0603X7R104K16TRPF
7	2	C11, C49	CAP CER 68pF 50V 5% NPO 0603	AVX: 06035A680JAT2A
8	9	C13, C33, C34, C35, C36, C54, C55, C56, C57	CAP CER 22 μ F 10V 10% X5R 1210	Kemet: C1210C226K8PACTU
9	1	C14	CAP CER 47pF 50V 5% NPO 0603	AVX: 06035A470JAT2A
10	7	C15, C16, C17, C25, C26, C27, C42	CAP CER 1 μ F 16V 10% X7R 0603	Taiyo Yuden: EMK107B7105KA-T
11	1	C32	CAP TANT 47 μ F 16V 20% 2917	Kemet: T520D476M016ATE035
12	2	C43, C47	CAP CER 4.7 μ F 16V 10% X5R 0603	TDK: C1608X5R1C475K
13	1	C44	CAP CER 10000pF 25V 10% X7R 0603	TDK: C1608X7R1H103K
14	1	C48	CAP CER 4.7pF 50V NPO 0603	Murata: GRM1885C1H4R7CZ01D
15	1	D1	DUAL DIODE SCHOTTKY 30V CC SOT-323-3	Diodes/Zetex: SBR0330CW-7
16	8	L1, L2, L3, L4, L6, L7, L8, L9	INDUCTOR SHLD POWER 4.7 μ H SMD	Abracon Corporation: ASPI-0315FS-4R7M-T2
17	1	L5	INDUCTOR POWER 2.2 μ H 2.85A SMD	Vishay: IHLP1616BZER2R2M01
18	9	LED3, P1, P2, P3, P4, P5, P6, P7, P8	LED GREEN SS TYPE BRIGHT SMD	Panasonic - SSG: LNJ337W83RA
19	2	LED1, LED2	LED RED HI BRT SS TYPE LO CUR SM	Panasonic - SSG: LNJ208R8ARA
20	9	Q1, Q2, Q3, Q4, Q5, Q6, Q7, Q8, Q9	MOSFET N-CH 30V 900MA SOT323-3	Vishay/Siliconix: S11308EDL-T1-GE3
21	17	R1, R2, R3, R4, R37, R38, R39, R40, R45, R46, R47, R48, R68, R80, R81, R82, R83	RES 100k Ω 1/10W 1% 0603 SMD	Vishay: CRCW0603100KFKEA
22	1	R5	RES 200k Ω 1/10W 1% 0603 SMD	Vishay: CRCW0603200KJNEA
23	1	R6	RES 115k Ω 1/10W 1% 0603 SMD	Vishay: CRCW0603115KFKEA
24	1	R7	RES 80.6k Ω 1/10W 1% 0603 SMD	Vishay: CRCW060380K6FKEA
25	1	R8	RES 66.5k Ω 1/10W 1% 0603 SMD	Vishay: CRCW060366K5FKEA
26	9	R9, R10, R11, R12, R16, R26, R27, R28, R29	RES 3.01k Ω 1/10W 1% 0603 SMD	NIC: NRC06F3011TRF
27	12	R14, R18, R19, R22, R23, R30, R35, R36, R57, R58, R60, R88	RES 10.0k Ω 1/10W 1% 0603 SMD	Vishay: CRCW060310K0FKEA
28	2	R15, R71	RES 73.2k Ω 1/10W 1% 0603 SMD	Vishay: CRCW060373K2FKEA
29	1	R17	RES 46.4k Ω 1/10W 1% 0603 SMD	NIC: NRC06F4642TRF
30	2	R20, R25	RES 249 Ω 1/10W 1% 0603 SMD	NIC: NRC06F2490TRF
31	1	R21	RES 1.00k Ω 1/10W 1% 0603 SMD	NIC: NRC06F1001TRF
32	2	R24, R59	RES ARRAY 10k Ω 4 RES 1206	Vishay Dale: CRA06S08310K0JTA

PARTS LIST

ITEM	QTY	REFERENCE	PART DESCRIPTION	MANUFACTURER/PART NUMBER
33	1	R31	RES 47.5kΩ 1/10W 1% 0603 SMD	Vishay: CRCW060375K5FKEA
34	1	R32	RES 42.2kΩ 1/10W 1% 0603 SMD	NIC: NRC06F4222TRF
35	1	R33	RES 36.5kΩ 1/10W 1% 0603 SMD	Vishay: CRCW060336K5FKEA
36	1	R34	RES 32.4kΩ 1/10W 1% 0603 SMD	Vishay: CRCW060332K4FKEA
37	8	R41, R42, R43, R44, R84, R85, R86, R87	RES 470Ω 1/4W 5% 1210 SMD	Vishay CRCW1210470RFKEA
38	8	R49, R51, R53, R55, R73, R75, R77, R79	RES 100Ω 1/10W 1% 0603 SMD	NIC: NRC06F1000TRF
39	1	R50	RES 158kΩ 1/10W 1% 0603 SMD	Vishay: CRCW0603158KFKEA
40	1	R52	RES 174kΩ 1/10W 1% 0603 SMD	NIC: NRC06F1743TRF
41	1	R54	RES 196kΩ 1/10W 1% 0603 SMD	Vishay: CRCW0603196KFKEA
42	1	R56	RES 210kΩ 1/10W 1% 0603 SMD	Vishay: CRCW0603210KFKEA
43	0	R61 (OPT)	RES 10.0kΩ 1/10W 1% 0603 SMD	Vishay: CRCW060310K0FKEA
44	2	R62, R67	RES 698Ω 1/10W 1% 0603 SMD	Vishay: CRCW0603698RFKEA
45	1	R63	RES 2.49kΩ 1/10W 1% 0603 SMD	Vishay: CRCW06032K49FKEA
46	1	R72	RES 261kΩ 1/10W 1% 0603 SMD	Vishay: CRCW0603261KFKEA
47	1	R74	RES 294kΩ 1/10W 1% 0603 SMD	Vishay: CRCW0603294KFKEA
48	1	R76	RES 348kΩ 1/10W 1% 0603 SMD	Vishay: CRCW0603348KFKEA
49	1	R78	RES 442kΩ 1/10W 1% 0603 SMD	Vishay: CRCW0603442KFKEA
50	8	U1, U2, U3, U4, U9, U10, U11, U12	IC BUCK SYNC ADJ 0.3A SOT23-6	Linear Technology: LTC3405AES6#TRMPBF
51	1	U5	IC BUCK SYNC 2.5A 16QFN	Linear Technology: LTC3604IUD#PBF
52	1	U7	IC DUAL 4A DIODES 16-MSOP	Linear Technology: LTC4415IMSE#PBF
53	1	U8	IC 2WIRE BUS BUFFER 8MSOP	Linear Technology: LTC4313CMS8-2#PBF
54	1	U13	IC I/O EXPANDER I ² C 8B 20QFN	Microchip: MCP23008-E/ML
55	1	U14	IC EEPROM 2kBIT 400kHz SOT23-5	Microchip Technology: 24AA02T-I/OT
56	1	U15	IC VREF SERIES PREC TSOT-23-6	Linear Technology: LT6654BMPS6-1.25#TRMPBF
57	1	U16	IC BUFFER DUAL NON-INV SC706	TI: SN74LVC2G34DCKR

Hardware: For Demo Board Only

58	1	J1	CONN PWR JACK 2.1 x 5.5mm HIGH CUR	CUI Inc: PJ-002AH
59	1	J2	CONN HEADER 12POS 2mm STR DL PCB	FCI: 98414-G06-12ULF
60	1	JP1	CONN RECEPT 2mm DUAL R/A 14POS	Sullins Connector Solutions: NPPN072FJFN-RC
61	1	JP2	CONN HEADER 14POS 2mm R/A GOLD	Molex Connector Corporation: 87760-1416
62	1	JP3	SWITCH DIP 4POS HALF PITCH SMD	C&K Components: TDA04H0SB1
63	4	MH1, MH2, MH3, MH4	SPACER STACKING #4 SCREW NYLON	Keystone: 8831
64	1	S1	SW SLIDE DPDT 6VDC 0.3A PCMNT	C&K Components: JS202011CQN
65	1	SW1	SWITCH TACTILE BLK SPST-NO 0.05A 12V	C&K Components: PTS635SL25SMTR LFS
66	1	SW2	SWITCH TACTILE RED SPST-NO 0.05A 12V	C&K Components: PTS635SK25SMTR LFS
67	20	TP1, TP2, TP3, TP4, TP5, TP6, TP7, TP8, TP9, TP10, TP11, TP12, TP13, TP14, TP15, TP16, TP17, TP18, TP19, TP20	TERM SOLDER TURRET 0.219" 0.078"L	MILL-MAX: 2501-2-00-80-00-00-07-0

SCHEMATIC DIAGRAM

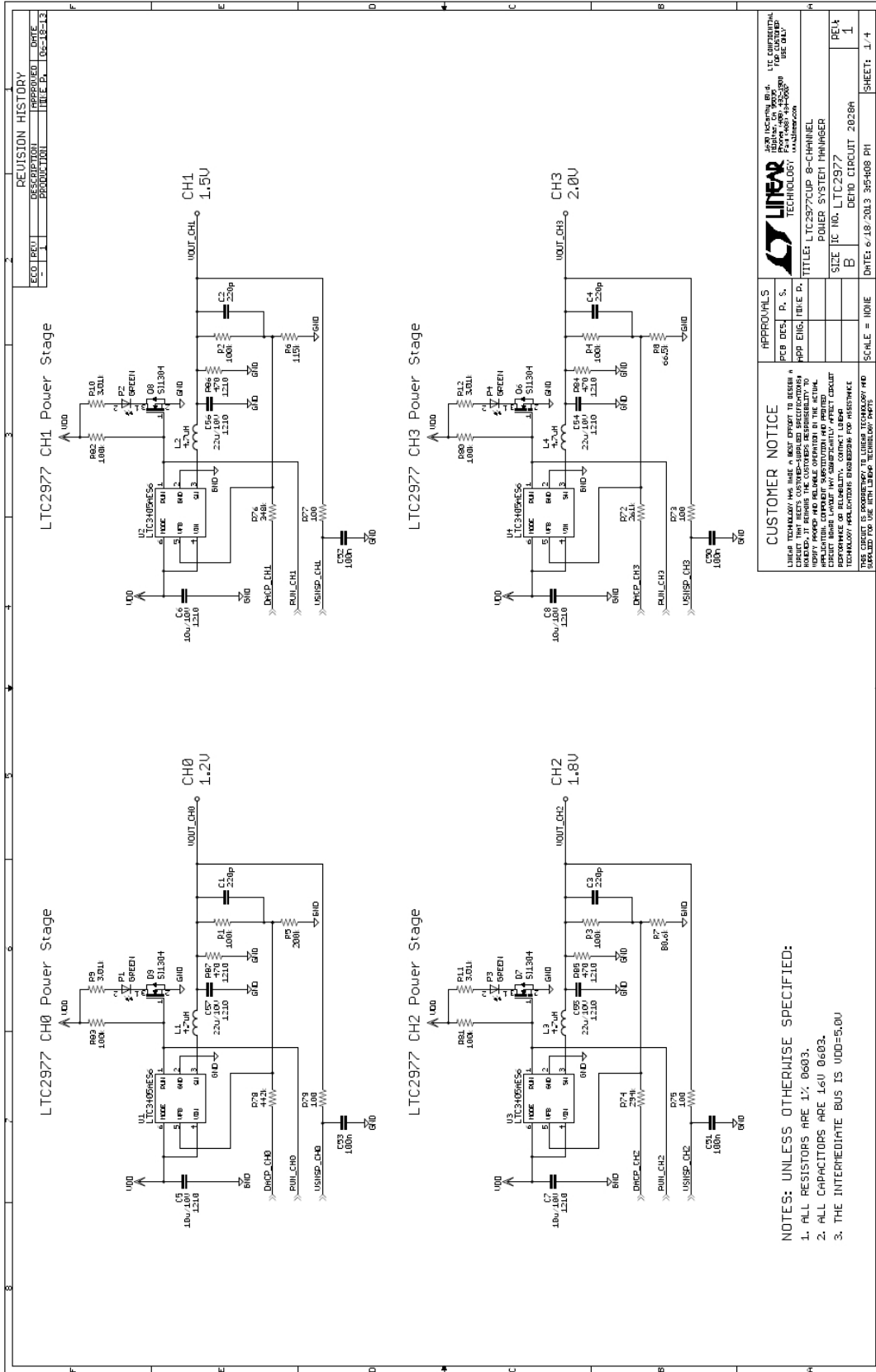

SCHEMATIC DIAGRAM

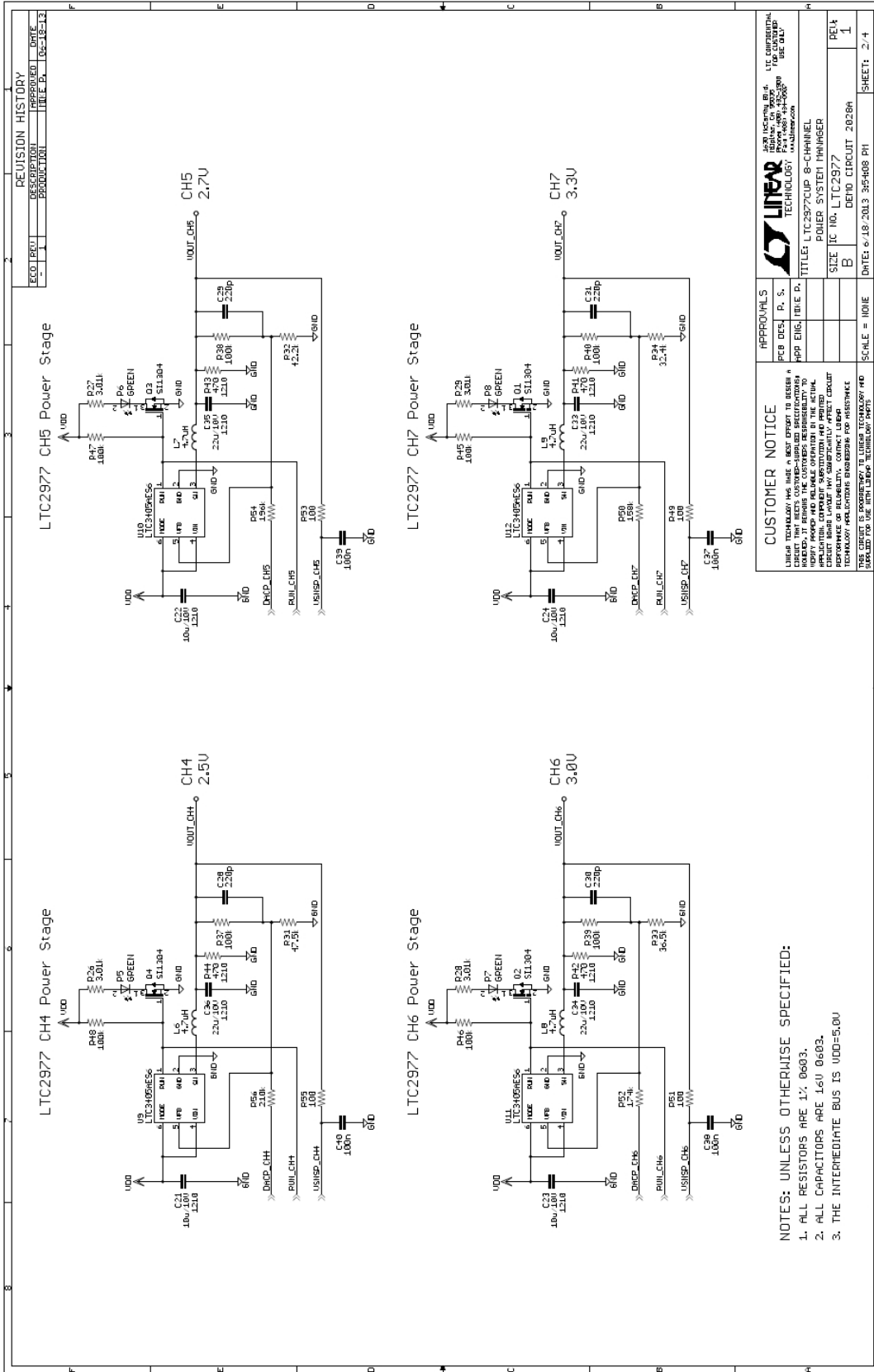

SCHEMATIC DIAGRAM

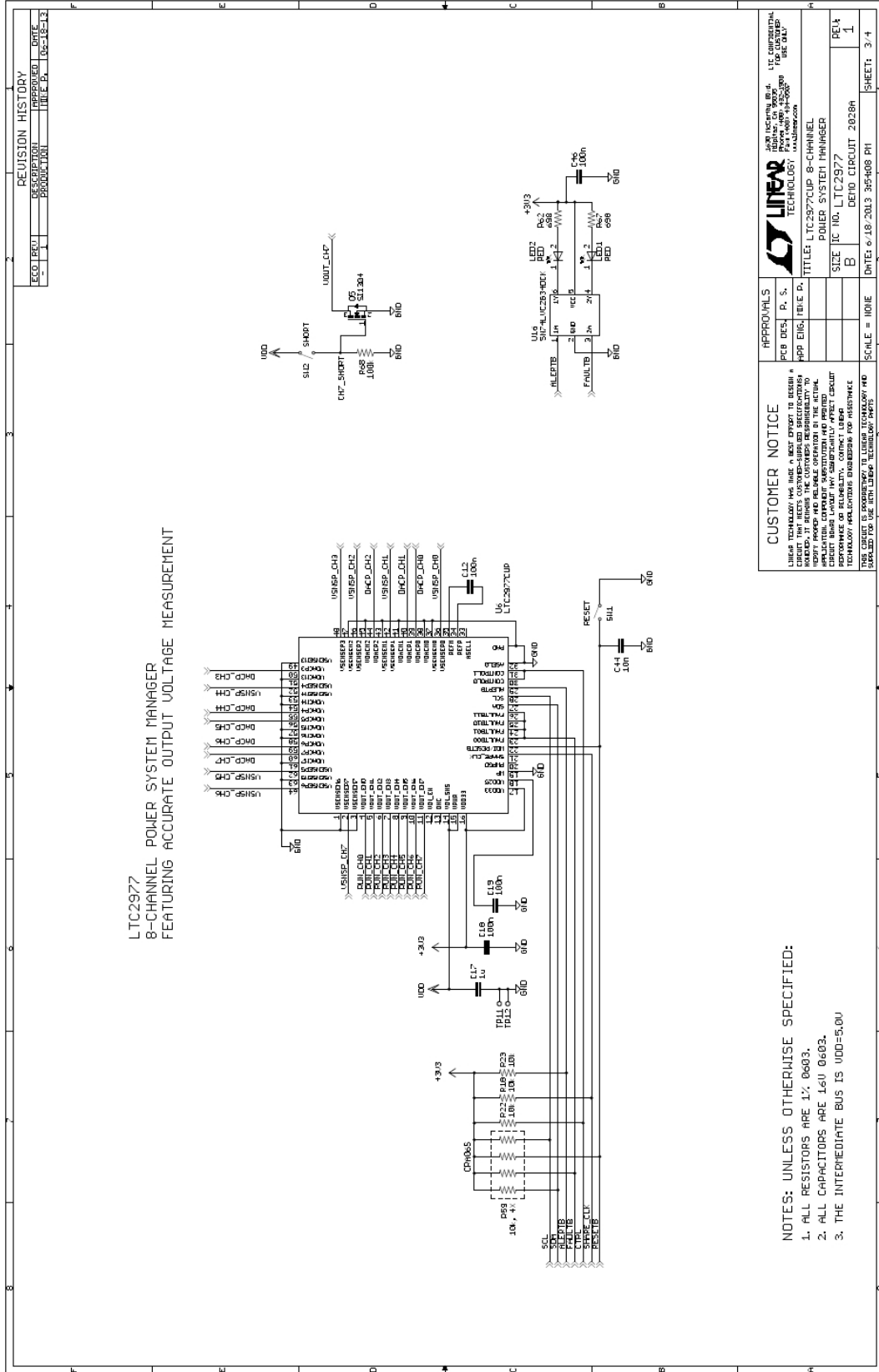

SCHEMATIC DIAGRAM

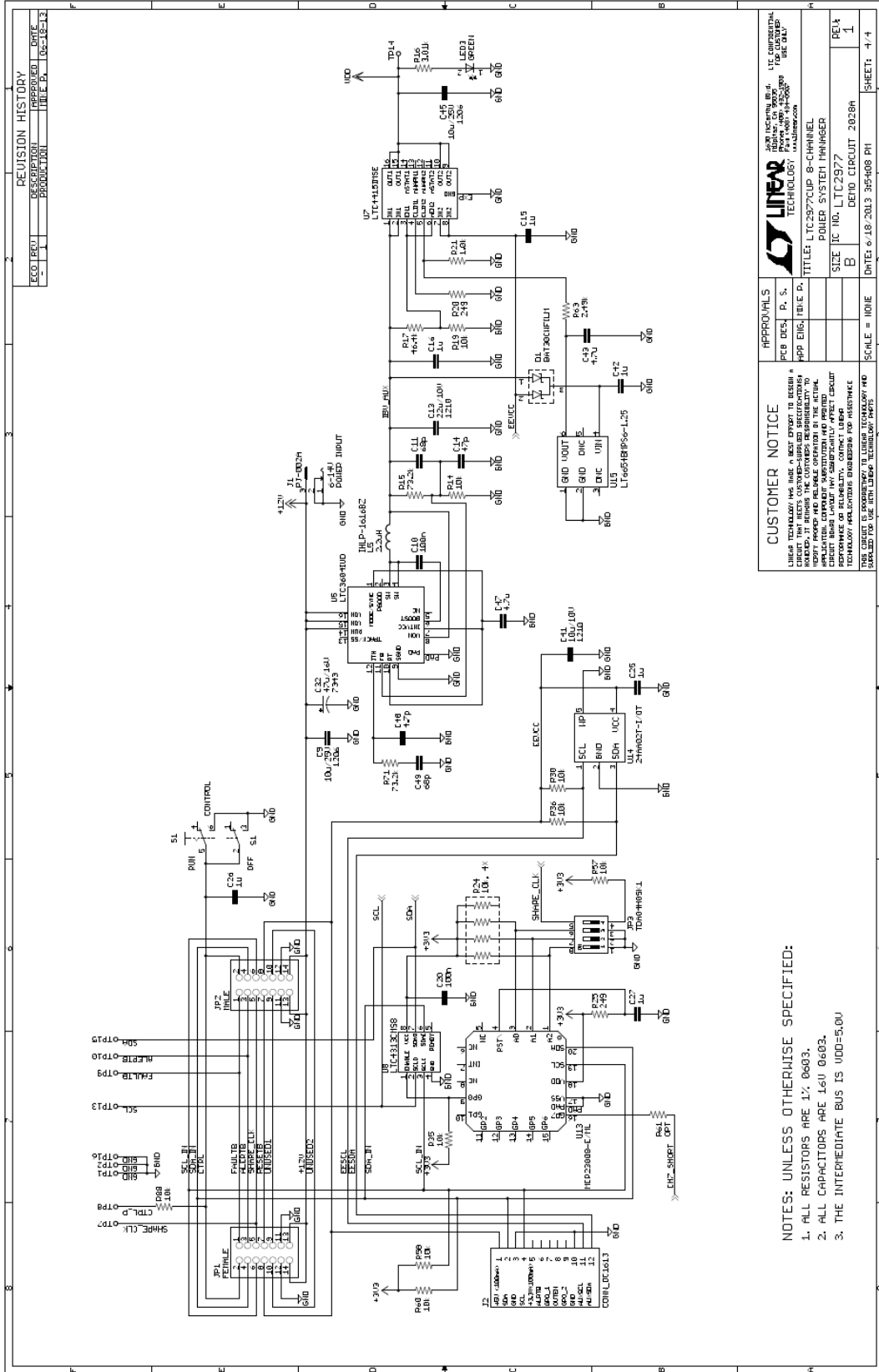

REVISION HISTORY

ECO	REV	DESCRIPTION	APPROVED	DATE
-	1	PRODUCTION	TRC/PA	10-08-03

CUSTOMER NOTICE

LINEAR TECHNOLOGY HAS MADE GREAT EFFORT TO DESIGN A CIRCUIT THAT MEETS CUSTOMER-SPECIFIED REQUIREMENTS. HOWEVER, WE CANNOT GUARANTEE PERFORMANCE IN ALL APPLICATIONS. CUSTOMER VERIFICATION AND PROPER APPLICATION OF THE TECHNOLOGY IS REQUIRED TO ACHIEVE THE SPECIFIED PERFORMANCE. CONTACT YOUR LOCAL SALES REPRESENTATIVE FOR ASSISTANCE.

THIS CIRCUIT IS PROVIDED BY LINEAR TECHNOLOGY AS A DEMO BOARD FOR THE WITH LIMITED TECHNICAL SUPPORT.

APPROVALS

PEB DES.	P. S.
APP. ENG.	TRC/PA

LINEAR TECHNOLOGY
 2000 WILLIAMS BLVD., WILMINGTON, MA 01890
 TEL: 617-261-1000 FAX: 617-261-1001
 WWW.LINEARTECH.COM

TITLE LTC2977CUP 8-CHANNEL POWER SYSTEM MGR
SIZE IC NO. LTC2977
B DEMO CIRCUIT 2028A
DATE 018-2013 305-H08 PH
SCALE = NONE
SHEET = 1/4

- NOTES: UNLESS OTHERWISE SPECIFIED:**
1. ALL RESISTORS ARE 1% 0603.
 2. ALL CAPACITORS ARE 16U 0603.
 3. THE INTERMEDIATE BUS IS 1000=5.0U



Information furnished by Linear Technology Corporation is believed to be accurate and reliable. However, no responsibility is assumed for its use. Linear Technology Corporation makes no representation that the interconnection of its circuits as described herein will not infringe on existing patent rights.

DEMO MANUAL DC2028A

DEMONSTRATION BOARD IMPORTANT NOTICE

Linear Technology Corporation (LTC) provides the enclosed product(s) under the following **AS IS** conditions:

This demonstration board (DEMO BOARD) kit being sold or provided by Linear Technology is intended for use for **ENGINEERING DEVELOPMENT OR EVALUATION PURPOSES ONLY** and is not provided by LTC for commercial use. As such, the DEMO BOARD herein may not be complete in terms of required design-, marketing-, and/or manufacturing-related protective considerations, including but not limited to product safety measures typically found in finished commercial goods. As a prototype, this product does not fall within the scope of the European Union directive on electromagnetic compatibility and therefore may or may not meet the technical requirements of the directive, or other regulations.

If this evaluation kit does not meet the specifications recited in the DEMO BOARD manual the kit may be returned within 30 days from the date of delivery for a full refund. **THE FOREGOING WARRANTY IS THE EXCLUSIVE WARRANTY MADE BY THE SELLER TO BUYER AND IS IN LIEU OF ALL OTHER WARRANTIES, EXPRESSED, IMPLIED, OR STATUTORY, INCLUDING ANY WARRANTY OF MERCHANTABILITY OR FITNESS FOR ANY PARTICULAR PURPOSE. EXCEPT TO THE EXTENT OF THIS INDEMNITY, NEITHER PARTY SHALL BE LIABLE TO THE OTHER FOR ANY INDIRECT, SPECIAL, INCIDENTAL, OR CONSEQUENTIAL DAMAGES.**

The user assumes all responsibility and liability for proper and safe handling of the goods. Further, the user releases LTC from all claims arising from the handling or use of the goods. Due to the open construction of the product, it is the user's responsibility to take any and all appropriate precautions with regard to electrostatic discharge. Also be aware that the products herein may not be regulatory compliant or agency certified (FCC, UL, CE, etc.).

No License is granted under any patent right or other intellectual property whatsoever. **LTC assumes no liability for applications assistance, customer product design, software performance, or infringement of patents or any other intellectual property rights of any kind.**

LTC currently services a variety of customers for products around the world, and therefore this transaction **is not exclusive**.

Please read the DEMO BOARD manual prior to handling the product. Persons handling this product must have electronics training and observe good laboratory practice standards. **Common sense is encouraged.**

This notice contains important safety information about temperatures and voltages. For further safety concerns, please contact a LTC application engineer.

Mailing Address:

Linear Technology
1630 McCarthy Blvd.
Milpitas, CA 95035

Copyright © 2004, Linear Technology Corporation