

CPINUC5206-HF

RoHS Device
Halogen Free



Features

- Low series resistance.
- Low insertion loss.
- Low capacitance.
- High isolation.

Mechanical data

- Case: SOD-523F (0603C) standard package molded plastic.
- Terminals: Matte tin plated, Solderable per MIL-STD-750, Method 2026.
- Polarity: Indicated by cathode band.
- Weight: 0.003 grams(approx.).

Circuit diagram

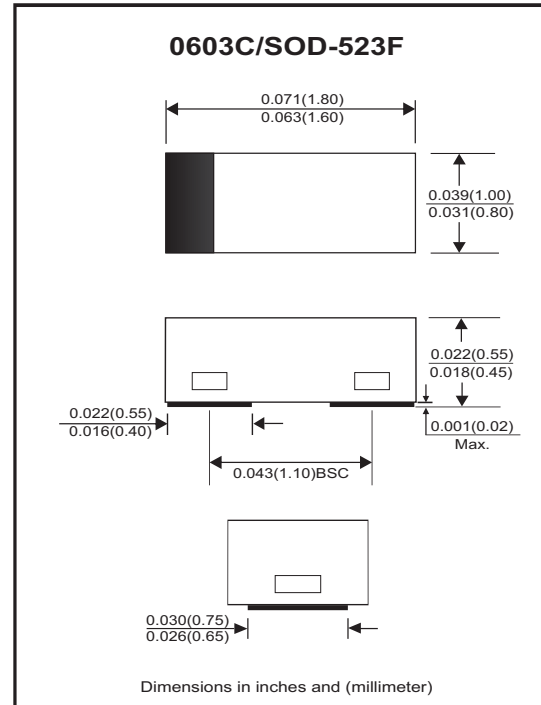

Maximum Rating (at $T_A=25^\circ\text{C}$ unless otherwise noted)

Parameter	Conditions	Symbol	Value	Unit
Reverse voltage		V_R	180	V
Power dissipation	Mounting on glass epoxy PCB (50mm x 50mm x 1.6mm)	P_D	300	mW
Junction temperature range		T_J	150	$^\circ\text{C}$
Storage temperature range		T_{STG}	-55~+150	$^\circ\text{C}$

Electrical Characteristics (at $T_A=25^\circ\text{C}$ unless otherwise noted)

Parameter	Conditions	Symbol	Min	Typ	Max	Unit
Reverse current	$V_R = 180\text{V}$	I_R			10	μA
Forward voltage	$I_F = 50\text{mA}$	V_F			1.0	V
Forward series resistance	$I_F = 50\text{mA}$, $f = 100\text{MHz}$	R_{fs}		1.0	1.5	Ω
Diode capacitance	$V_R = 40\text{V}$, $f = 100\text{MHz}$	C_T		0.15	0.22	pF
Parallel resistance	$V_R = 0\text{V}$, $f = 100\text{MHz}$	R_p	5.0	10.0		k Ω
Insertion loss	$I_F = 30\text{mA}$, $f = 3\text{GHz}$	$I_L (1)$		-0.18		dB
Isolation	$V_R = -20\text{V}$, $f = 3\text{GHz}$	$I_{so} (1)$		-10		dB

Notes: 1. Series configuration $Z_o=50\Omega$. Losses of test fixtures are excluded from the measuring data.

TYPICAL PERFORMANCE CHARACTERISTICS (CPINUC5206-HF)

Fig.1 - Forward Current vs. Forward Voltage Characteristics

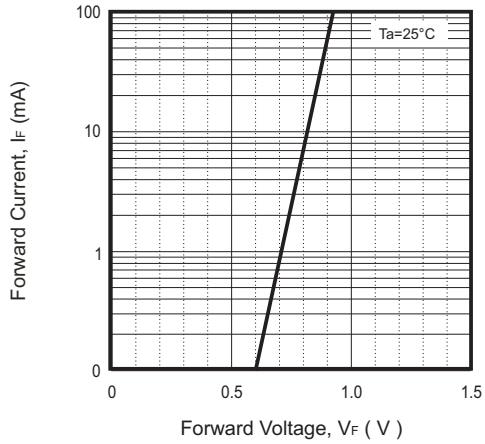

Fig.2 - Reverse Current vs. Reverse Voltage Characteristics

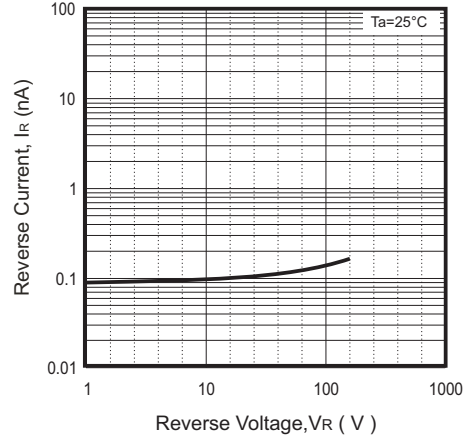

Fig.3 - Forward Series Resistance Vs. Forward Current Characteristics

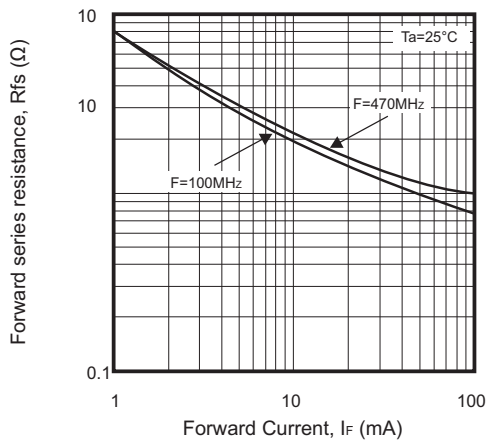
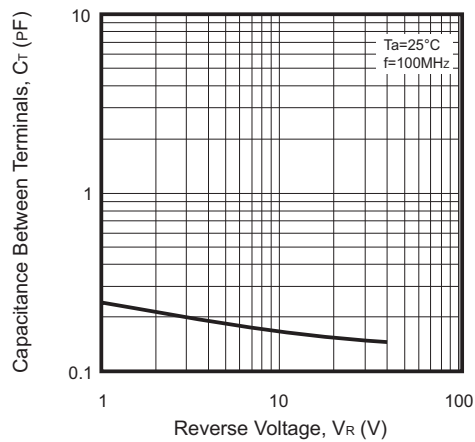
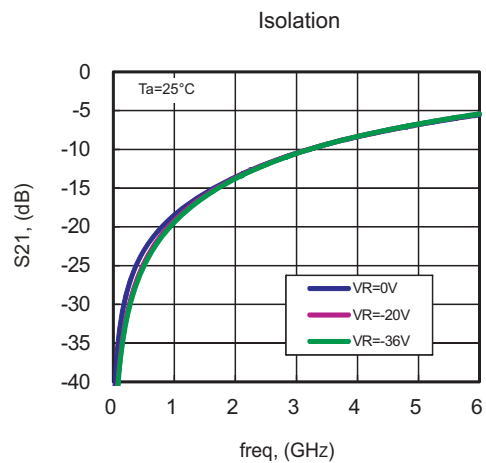
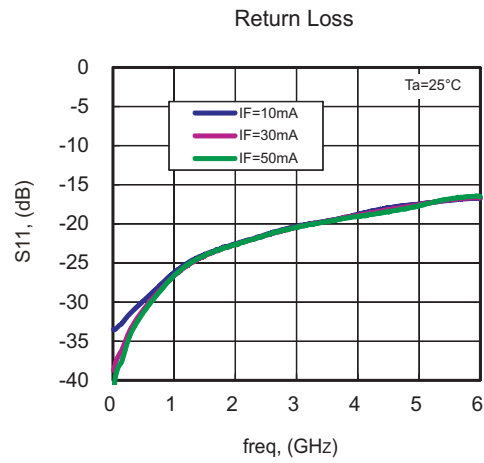
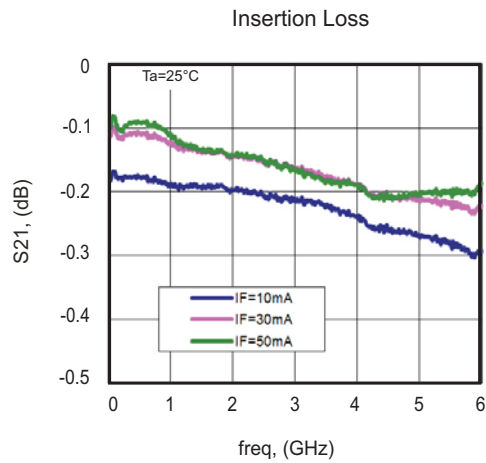

Fig.4 - Diode Capacitance Vs. Reverse Voltage Characteristics



TYPICAL PERFORMANCE CHARACTERISTICS (CPINUC5206-HF)



***) Series configuration. $Z_0=50\Omega$**
Losses of test fixtures are excluded from the measuring date.

Reel Taping Specification

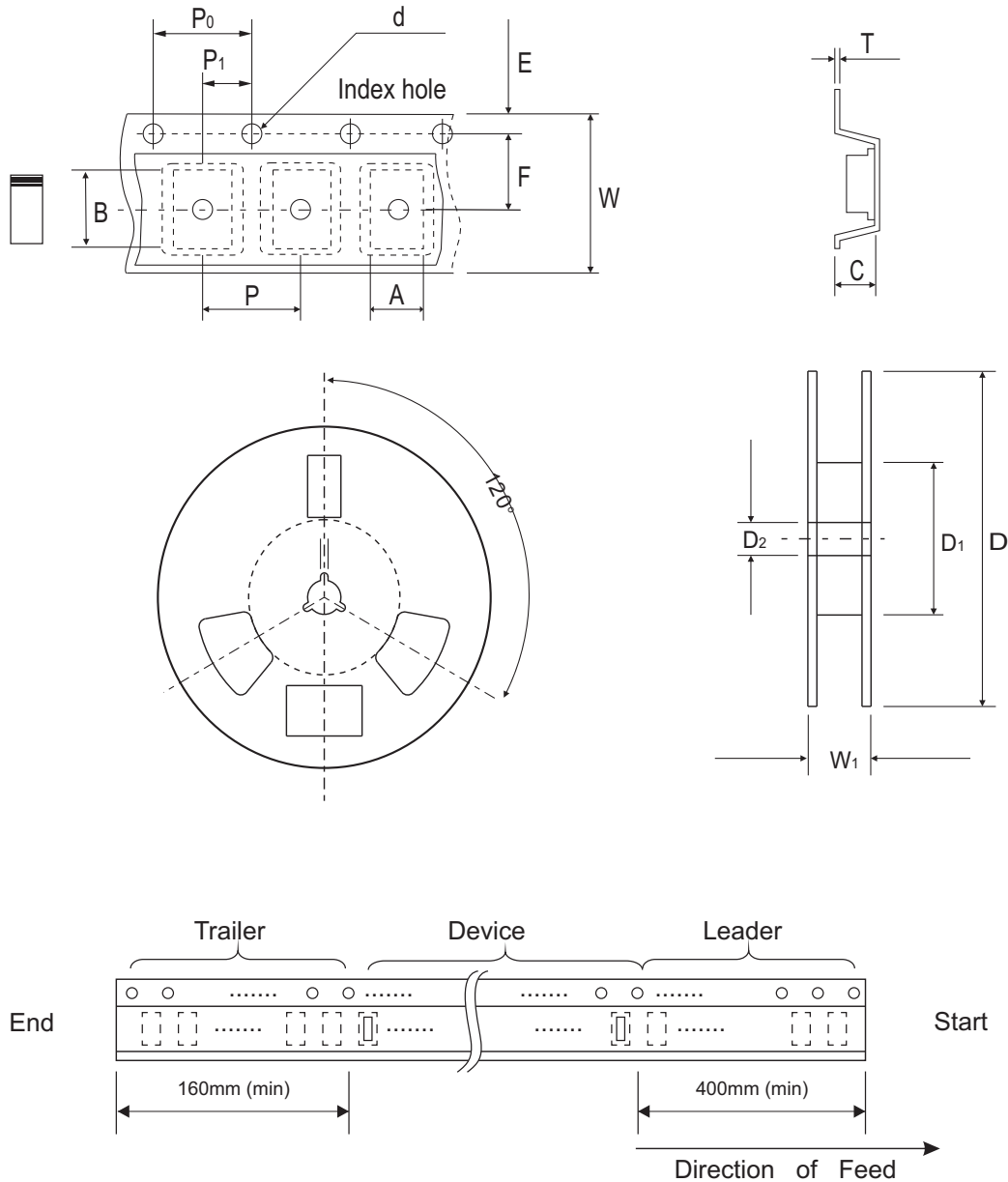

0603C/ SOD-523F	SYMBOL	A	B	C	d	D	D ₁	D ₂
	(mm)	1.05 ± 0.05	1.96 ± 0.05	0.57 ± 0.05	1.50 + 0.10 - 0	178.00 ± 1.00	60.00 ± 0.50	13.50 ± 0.20
	(inch)	0.041 ± 0.002	0.077 ± 0.002	0.022 ± 0.002	0.059 + 0.004 - 0	7.008 ± 0.039	2.362 ± 0.020	0.531 ± 0.008

0603C/ SOD-523F	SYMBOL	E	F	P	P ₀	P ₁	T	W	W ₁
	(mm)	1.75 ± 0.10	3.50 ± 0.05	4.00 ± 0.10	4.00 ± 0.05	2.00 ± 0.05	0.20 ± 0.03	8.00 ± 0.20	12.00 + 0.50 - 0
	(inch)	0.069 ± 0.004	0.138 ± 0.002	0.157 ± 0.004	0.157 ± 0.002	0.079 ± 0.002	0.008 ± 0.001	0.315 ± 0.008	0.472 + 0.020 - 0

Marking Code

Part Number	Marking Code
CPINUC5206-HF	L4XXX



XXX = Lot Code (3~4 digits)

Suggested PAD Layout

SIZE	0603C/SOD-523F	
	(mm)	(inch)
A	1.10	0.043
B	0.60	0.024
C	0.80	0.031
D	1.70	0.067
E	0.50	0.020

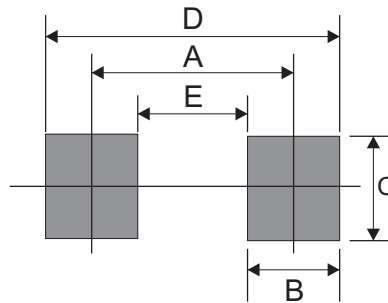

Standard Packaging

Case Type	REEL PACK	
	REEL (pcs)	Reel Size (inch)
0603C/SOD-523F	4,000	7