

MAX5980 Evaluation Kit

Evaluates: MAX5980

General Description

The MAX5980 evaluation kit (EV kit) is a fully assembled and tested surface-mount circuit board featuring an Ethernet 4-port power-sourcing equipment (PSE) circuit for -48V or -54V supply rail systems. The IEEE® 802.3af/at-compliant MAX5980 PSE controller, in a 32-pin TQFN-EP package, and four n-channel power MOSFETs are used to form the main PSE circuit on the EV kit. The IC is used in Power-over-Ethernet (PoE) applications requiring DC power over four Ethernet network ports. The EV kit provides optical isolation for the I²C-compatible 3-wire interface. The isolated interface can connect to a PC's USB port through an on-board USB interface circuit. The EV kit can easily be reconfigured for interfacing to a user's stand-alone microcontroller for isolated or nonisolated operation. In stand-alone operation, the user must supply a separate 3.3V power supply (with respect to VEE) capable of supplying 100mA for the EV kit's +3.3V optically isolated 3-wire interface.

The EV kit requires a -32V to -60V power supply (-48V/-54V supply rail) capable of supplying 4A or more to the EV kit for powering the powered device (PD) through the four 10/100/1000BASE-TX Ethernet network ports. The EV kit demonstrates PD discovery, classification, current-limit control, and other functions of an IEEE 802.3af/at-compliant PSE circuit.

The IC controls the -48V/-54V DC power to each of the four Ethernet network ports by controlling the ports' power MOSFET and sensing current through the respective port's current-sense resistor. The current is fed to a 10/100/1000BASE-TX magnetic module at each Ethernet output port. The EV kit provides a separate, independent power channel for each of the four Ethernet output ports.

The EV kit demonstrates the full functionality of the IC for each power channel, such as configurable operational modes, high-power mode (programmable up to 30W per port or up to 60W in a 2 x 2 pair configuration), port current information through the I²C interface, PD detection, PD classification, overcurrent protection, current fold-back, under/overvoltage protection, and DC disconnect monitoring. All these features are configurable on the EV kit. Additional test points for voltage probing and current measurements have also been provided.

The EV kit includes Windows XP®, Windows Vista®, and Windows® 7-compatible software and provides a user-friendly interface to demonstrate the features of the IC, while also providing access to each register at the bit level. The program is menu-driven and offers a graphical user interface (GUI) with control buttons. The program also includes a macro engine to allow automated evaluation and testing of the IC at the system level. The program's macro output files can be automatically saved.

For pricing, delivery, and ordering information, please contact Maxim Direct at 1-888-629-4642, or visit Maxim Integrated's website at www.maximintegrated.com.

Features

- ◆ IEEE 802.3af/at-Compliant PSE Circuit
- ◆ High-Power Mode (Programmable Up to 30W per Port or Up to 60W in a 2 x 2 Pair Configuration)
- ◆ Port Current Readout Through the I²C Interface
- ◆ Input Voltages
 - ◇ -32V to -60V Providing 4A (-48V/-54V Power Circuit, 1A/Port)
- ◆ Ethernet Network Ports
 - ◇ Four RJ45 10/100/1000BASE-TX Ethernet Network Input Ports
 - ◇ Four RJ45 10/100/1000BASE-TX Ethernet Network Output PoE Ports
- ◆ Demonstrates Four Separate Independent Power Switch Controllers
- ◆ Demonstrates PD Detection and Classification
- ◆ DC Load Removal Detection and Disconnect Monitoring
- ◆ Convenient Voltage and Current Test Points
- ◆ Four Output-Port LED Status Indicators
- ◆ Optically Isolated I²C-Compatible 3-Wire PC Interface
- ◆ Reconfigurable for Stand-Alone Operation or with an External Microcontroller (Requires a +3.3V, 100mA Supply)
- ◆ Windows XP-, Windows Vista-, and Windows 7-Compatible Software
- ◆ Proven PCB Layout
- ◆ Fully Assembled and Tested

[Ordering Information](#) appears at end of data sheet.

IEEE is a registered service mark of the Institute of Electrical and Electronics Engineers, Inc.

Windows, Windows XP, and Windows Vista are registered trademarks and registered service marks of Microsoft Corporation.

MAX5980 Evaluation Kit

Evaluates: MAX5980

Component List

DESIGNATION	QTY	DESCRIPTION
C1	1	220 μ F \pm 20%, 100V electrolytic capacitor (18 x 16.5) Panasonic EEVFK2A221M
C3, C214	2	1 μ F \pm 10%, 10V X5R ceramic capacitors (0603) Murata GRM188R61A105K
C6	1	1 μ F \pm 10%, 100V X7R ceramic capacitor (1210) AVX 12101C105KAT9A
C7	1	1000pF \pm 10%, 50V X7R ceramic capacitor (0603) Murata GRM188R71H102K
C8	1	10 μ F \pm 20%, 6.3V X5R ceramic capacitor (0603) Murata GRM188R60J106M
C9	1	0.033 μ F \pm 10%, 16V X7R ceramic capacitor (0603) Murata GRM188R71C333K
C10, C11, C12, C17	0	Not installed, ceramic capacitors (0805)
C13, C18, C26–C29	6	0.1 μ F \pm 10%, 100V X7R ceramic capacitors (0805) AVX 08051C104KA
C36, C38, C201, C203–C210, C217, C221	13	0.1 μ F \pm 10%, 16V X7R ceramic capacitors (0603) Murata GRM188R71C104K
C202, C213, C215	3	10 μ F \pm 20%, 6.3V X5R ceramic capacitors (0805) Murata GRM21BR60J106M
C211, C212	2	10pF \pm 5%, 50V C0G ceramic capacitors (0603) Murata GRM1885C1H100J
C216	1	2.2 μ F \pm 10%, 6.3V X5R ceramic capacitor (0603) Murata GRM188R60J225K
C218, C219	2	22pF \pm 5%, 50V C0G ceramic capacitors (0603) Murata GRM1885C1H220J
C220	1	3300pF \pm 10%, 50V X7R ceramic capacitor (0603) Murata GRM188R71H332K
D9–D12	4	60V, 600W transient voltage suppressors (SMB) Fairchild SMBJ54A

DESIGNATION	QTY	DESCRIPTION
D13–D16	4	Green surface-mount LEDs (1206)
D22	1	60V, 6.2A transient voltage-suppressor diode (SMB) Diodes Incorporated SMBJ60A-13-F
D201	1	Green LED (0603)
FB201	0	Not installed, ferrite bead (0603)
GND, VEE	2	Uninsulated banana jacks
GND	4	Red miniature PC test point
J2	1	RJ45 2 x 4 gigabit MagJack [®] , 1000 Base-T, 2 x 4 ports, voice-over-IP magnetics (720mA DC) Bel Fuse Inc. 08542x4RZ5AF or Pulse Engineering J0B-306NL-Rev MX1 or Delta Electronics, Inc. RPGF-8MA8030-R
JU1–JU6	6	3-pin headers
JU8	1	2-pin header
JU9	0	Not installed, 10-pin (2 x 5) header
JU10, JU23–JU27, JU29, JU31–JU40	0	Not installed, 2-pin headers
JU11–JU14	0	Not installed, 4-pin (2 x 2) headers
JU28, JU30	0	Not installed, 3-pin headers
N1–N4	4	100V, 3.3A n-channel MOSFETs (Power 33) Fairchild FDMC3612
N5–N8	4	100V, 0.17A n-channel MOSFETs (SOT23) Fairchild BSS123
P201	1	-20V, -2.4A, p-channel MOSFET (3 SuperSOT) Fairchild FDN304P
R1–R4	4	0.250 Ω \pm 1%, 1W resistors (1206) IRC LRC-LR1206LF-01-R250-F
R5, R24, R27, R32, R64	5	10 Ω \pm 5% resistors (0603)
R6	1	1.8k Ω \pm 5% resistor (0603)
R9–R15, R17, R29, R30, R51, R53, R54, R77, R95, R96	16	3k Ω \pm 5% resistors (0603)

MagJack is a registered trademark of Bel Fuse Inc.

MAX5980 Evaluation Kit

Evaluates: MAX5980

Component List (continued)

DESIGNATION	QTY	DESCRIPTION
R16, R19, R26, R28, R31, R34, R201	7	0Ω ±5% resistors (0603)
R25, R33, R36, R57	0	Not installed, resistors (0603) 2kΩ ±5% recommended
R55	1	75Ω ±5% resistor (0603)
R56, R71, R94, R97	4	200Ω ±5% resistors (0603)
R58–R61	4	5.1kΩ ±5% resistors (0603)
R62, R63, R66, R67, R208	5	1kΩ ±5% resistors (0603)
R68	1	0Ω ±5% resistor (0805)
R73–R76	4	300kΩ ±5% resistors (0603)
R202	1	220Ω ±5% resistor (0603)
R203	1	10kΩ ±5% resistor (0603)
R204	1	2.2kΩ ±5% resistor (0603)
R205	1	1.5kΩ ±5% resistor (0603)
R206, R207	2	27Ω ±5% resistors (0603)
SW1	1	Micro-miniature pushbutton switch
U1	1	High-power quad PSE controller (32 TQFN-EP*) Maxim MAX5980GTJ+
U7, U8	2	High-speed 15Mbps logic-gate optocouplers (8 SO) CEL/NEC PS9821-2-AX
U9	1	TinyLogic UHS dual buffer with Schmitt trigger inputs (6 SC70) Fairchild NC7WZ17P6X

DESIGNATION	QTY	DESCRIPTION
U10	1	High-voltage linear regulator (6 TDFN-EP*) Maxim MAX6765TTSD2+T
U201	1	32-bit microcontroller (68 QFN-EP*) Maxim MAXQ2000-RAX+
U202	1	93C46 type 3-wire EEPROM (8 SO)
U203	1	UART-to-USB converter (32 TQFP, 7mm x 7mm)
U204	1	3.3V, 300mA regulator (5 SOT23) Maxim MAX8888EZK33+T
U205	1	2.5V, 120mA regulator (5 SC70) Maxim MAX8511EXK25+T
USB	1	USB type-B right-angle female connector
VDIG	1	Yellow miniature PC test point
VEE (2x), DGND (4x)	6	Black miniature PC test points
Y201	1	16MHz crystal Hong Kong X'tals SSM1600000E18FAF
Y202	1	6MHz crystal Hong Kong X'tals SSL6000000E18FAF
—	7	Shunts (JU1–JU6, JU8)
—	1	USB-A male to USB-B male connector, 6ft (beige)
—	1	PCB: MAX5980 EVALUATION KIT

*EP = Exposed pad.

Component Suppliers

SUPPLIER	PHONE	WEBSITE
AVX Corporation	843-946-0238	www.avxcorp.com
Bel Fuse Inc	201-432-0463	www.belfuse.com
CEL/NEC; California Eastern Laboratories	800-997-5227	www.cel.com
Delta Electronics, Inc.	510-668-5164	www.delta.com.tw
Diodes Incorporated	805-446-4800	www.diodes.com
Fairchild Semiconductor	888-522-5372	www.fairchildsemi.com
Hong Kong X'tals Ltd.	852-35112388	www.hongkongcrystal.com
IRC Inc.	361-992-7900	www.irctt.com
Murata Electronics North America, Inc.	770-436-1300	www.murata-northamerica.com
Panasonic Corp.	800-344-2112	www.panasonic.com
Pulse Engineering	858-674-8100	www.pulseeng.com

Note: Indicate that you are using the MAX5980 when contacting these component suppliers.

MAX5980 Evaluation Kit

Evaluates: MAX5980

MAX5980 EV Kit Files

FILE	DESCRIPTION
INSTALL.EXE	Installs the EV kit files on your computer
MAX5980.EXE	Application program
FTD2XX.INF	USB device driver file
POWER_ON.SMB	Bitmap macro routine
TEST#1_MANUAL_MODE.SMB	Bitmap macro routine
TEST#2_AUTO_MODE_DC.SMB	Bitmap macro routine
TEST#3_AUTO_MODE_AC.SMB	Bitmap macro routine
TEST#4_SEMIAUTO_MODE.SMB	Bitmap macro routine
UNINST.INI	Uninstalls the EV kit software
USB_Driver_Help.PDF	USB driver installation help file

Quick Start

Required Equipment

- MAX5980 EV kit (USB cable included)
- -32V to -60V, 4A-capable DC power supply
- User-supplied Windows XP, Windows Vista, or Windows 7 PC with a spare USB port
- USB I/O extension cable, straight-through, male-to-female cable
- Voltmeter for confirming output voltages

Caution: The GND banana jack is more positive than the VEE banana jack. Use an isolated oscilloscope for probing, with respect to VEE.

Note: In the following sections, software-related items are identified by bolding. Text in **bold** refers to items directly from the EV kit software. Text in **bold and underlined** refers to items from the Windows operating system.

Hardware Connections

The EV kit is fully assembled and tested. Follow the steps below to verify board operation. **Caution: Do not turn on the power supply until all connections are completed.**

- 1) Visit www.maximintegrated.com/evkitsoftware to download the latest version of the EV kit software, 5980RXX.ZIP. Save the EV kit software to a temporary folder and uncompress the ZIP file.
- 2) Install the EV kit software on your computer by running the INSTALL.EXE program inside the temporary folder. The program files are copied and icons are created in the Windows **Start | Programs** menu.
- 3) Verify that a shunt is installed across pins 1-2 on jumpers JU1 (A0, high), JU2 (A1, high), JU3 (A2, high),

and JU4 (A4, high) to set the IC's I²C-compatible slave address to 0x5E hexadecimal.

- 4) Verify that a shunt is installed across pins 2-3 on jumper JU5 (signal mode).
- 5) Verify that a shunt is installed across pins 1-2 on jumper JU6 (automatic mode).
- 6) Verify that no shunt is installed on jumper JU8 (Class 5 disabled).
- 7) Connect the -32V to -60V DC power supply to the metal VEE banana jack and the supply ground to the metal GND banana jack. Do not turn on the power supply until all connections are completed.
- 8) Connect a PD to the desired Ethernet output port's RJ45 connector (upper row) on the EV kit's 2 x 4 MagJack (J2) as listed below:
 - a. PORT1_OUT at upper row RJ45
 - b. PORT2_OUT at upper row RJ45
 - c. PORT3_OUT at upper row RJ45
 - d. PORT4_OUT at upper row RJ45
 - e. This step is optional if network connectivity and/or a PD is not required
- 9) Connect the EV kit's network input LAN port (lower row) to the corresponding PD LAN connection as listed below:
 - a. PORT1_IN at lower row RJ45
 - b. PORT2_IN at lower row RJ45
 - c. PORT3_IN at lower row RJ45
 - d. PORT4_IN at lower row RJ45
 - e. This step is optional if network connectivity is not required
- 10) Turn on the power supply.
- 11) Connect the USB cable from the PC to the EV kit board. A **New Hardware Found** window pops up when installing the USB driver for the first time. If a window is not seen that is similar to the one described above after 30s, remove the USB cable from the board and reconnect it. Administrator privileges are required to install the USB device driver on Windows.
- 12) Follow the directions of the **Found New Hardware** window to install the USB device driver. Manually specify the location of the device driver to be **C:\Program Files\MAX5980** (default installation directory) using the **Browse** button. During device driver installation, Windows may show a warning message indicating that the device driver Maxim uses does not contain a digital signature. This is not an error condition and it is safe to proceed with installation. Refer to the USB_Driver_Help.PDF document included with the software for additional information.

MAX5980 Evaluation Kit

Evaluates: MAX5980

- 13) Start the EV kit software by opening its icon in the **Start | Programs** menu.
- 14) Observe as the program automatically detects the USB interface circuit, starts the main program, and then automatically detects the I²C-compatible address configured for the IC.
- 15) Select the **BitMap Controls** tab at the top.
- 16) Load and run the POWER_ON.SMB macro program from the **File | Open | Run Macro** menu. The script automatically runs after selecting open.
- 17) All four network port's green status LEDs should be lit.
- 18) Three other example macros allow quick testing of the manual mode, auto mode, semiauto mode, and with DC load disconnect detection. These macros are:
 - a. TEST#1_MANUAL_MODE.SMB
 - b. TEST#2_AUTO_MODE_DC.SMB
 - c. TEST#4_SEMIAUTO_MODE.SMB
- 19) Read the embedded comments in each macro for detailed descriptions using a plain text editor.
- 20) Test point VEE (U1 VEE pin) and GND test points are provided throughout the PCB to observe desired signals with an oscilloscope or voltmeter. **Use an isolated oscilloscope for probing with respect to VEE and DGND.**
- 21) Header JU9 is provided to monitor the I²C signals on the U1 side. These signals are not isolated and are referenced to DGND. **DGND and VEE are shorted by a 0Ω resistor (R19). AGND and GND are shorted by a 0Ω resistor (R68).**
- 22) Pressing the reset pushbutton turns off power to all ports and returns the IC to the operation mode.

Note: An uninstall program is included with the software. Click on the UNINSTALL icon to remove the EV kit software from the hard drive.

Detailed Description of Software

Text in **bold** indicates user-selectable features in the EV kit software. Use the mouse or the keyboard's Tab key to navigate various items on the main window. The EV kit software features the **Configuration, Events and Status**, and **BitMap Controls** tab sheets. Most of the main window's available functions can be evaluated by using the pull-down menu. The bottom-left status bar provides the USB interface circuit status. The center status bar provides the current EV kit and macro engine status.

Software Startup

The EV kit software starts in the program's **Auto Read** state. The software automatically detects the **Slave Address** and begins reading the contents of each register from the IC, updating each tab sheet. The software then starts up with the **Events and Status** tab (Figure 1) for reading system and port events/status information.

Events and Status Tab

The **Events and Status** tab sheet contains the EV kit's system and port events/status information obtained from the IC registers. The **System Events and Status** group box provides system-level information on the VEE and VDD (VDIG) power supplies, over temperature, and the present operating mode and address in hexadecimal and decimal formats. The **Port Events** group box provides each PSE port event or change status, including each port's power MOSFET (FET_). The **Port Status** group box provides each PSE port operating status during detection, classification, current, and voltage usage by the connected PD.

Configuration Tab

The **Configuration** tab sheet (Figure 2) provides a high-level method of configuring the EV kit as a 4-port PSE. System and port-level configurations can be made in this window. Additionally, the IC or a specific port can be immediately reset using the respective **Reset** button. All other configuration changes on this window take place after the **Update MAX5980** button has been pressed. To view a specific port event or status after updating, select the **Events and Status** tab. Each ports' operating mode, disconnect mode, detection/classification, and various power settings can be set independently. After configuring the port or making system changes, press the **Update MAX5980** button to write these changes to the IC, thus updating the EV kit's respective PSE port. Certain configurations may not be enabled, depending on the IC's current state or status.

BitMap Controls Tab

The **BitMap Controls** tab sheet (Figure 3) provides a bit-level method for configuring the EV kit as a 4-port PSE and for controlling the software state, configuring the IC registers, using the macro engine, and displaying all the registers in binary and hexadecimal format.

The IC's register contents are placed in the appropriate line of the **Reg Read** tables in binary and hexadecimal format. If data changes between the next register read, the updated register hexadecimal data is displayed in red and blinks four times. The blink rate can be changed using the **Commands | Red Hex Data Blink Rate** menu item. The bottom-left status bar provides the USB interface circuit status. The center status bar provides the current EV kit and macro engine status.

MAX5980 Evaluation Kit

Evaluates: MAX5980

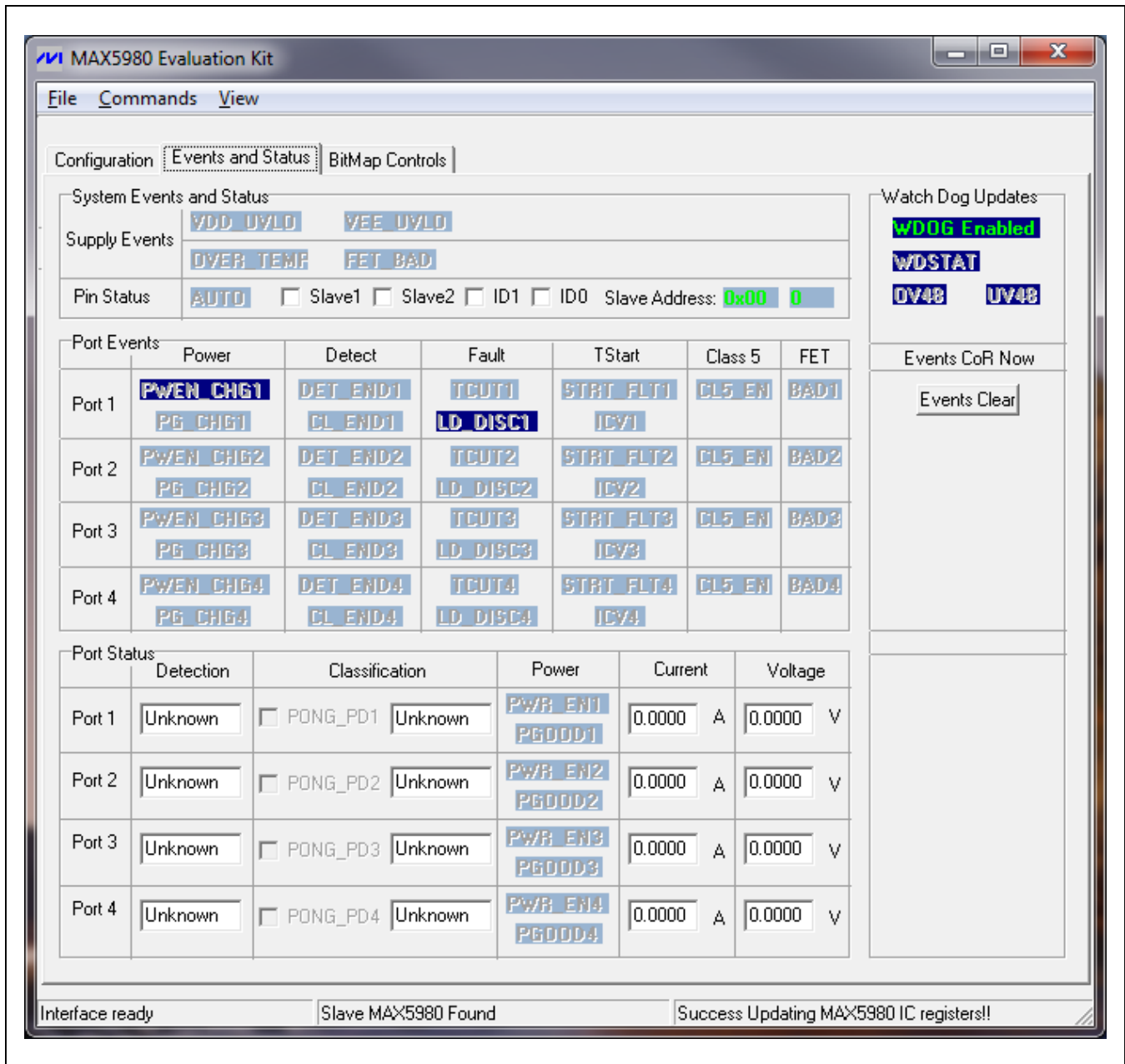

Figure 1. MAX5980 EV Kit Software (Events and Status Tab)

MAX5980 Evaluation Kit

Evaluates: MAX5980

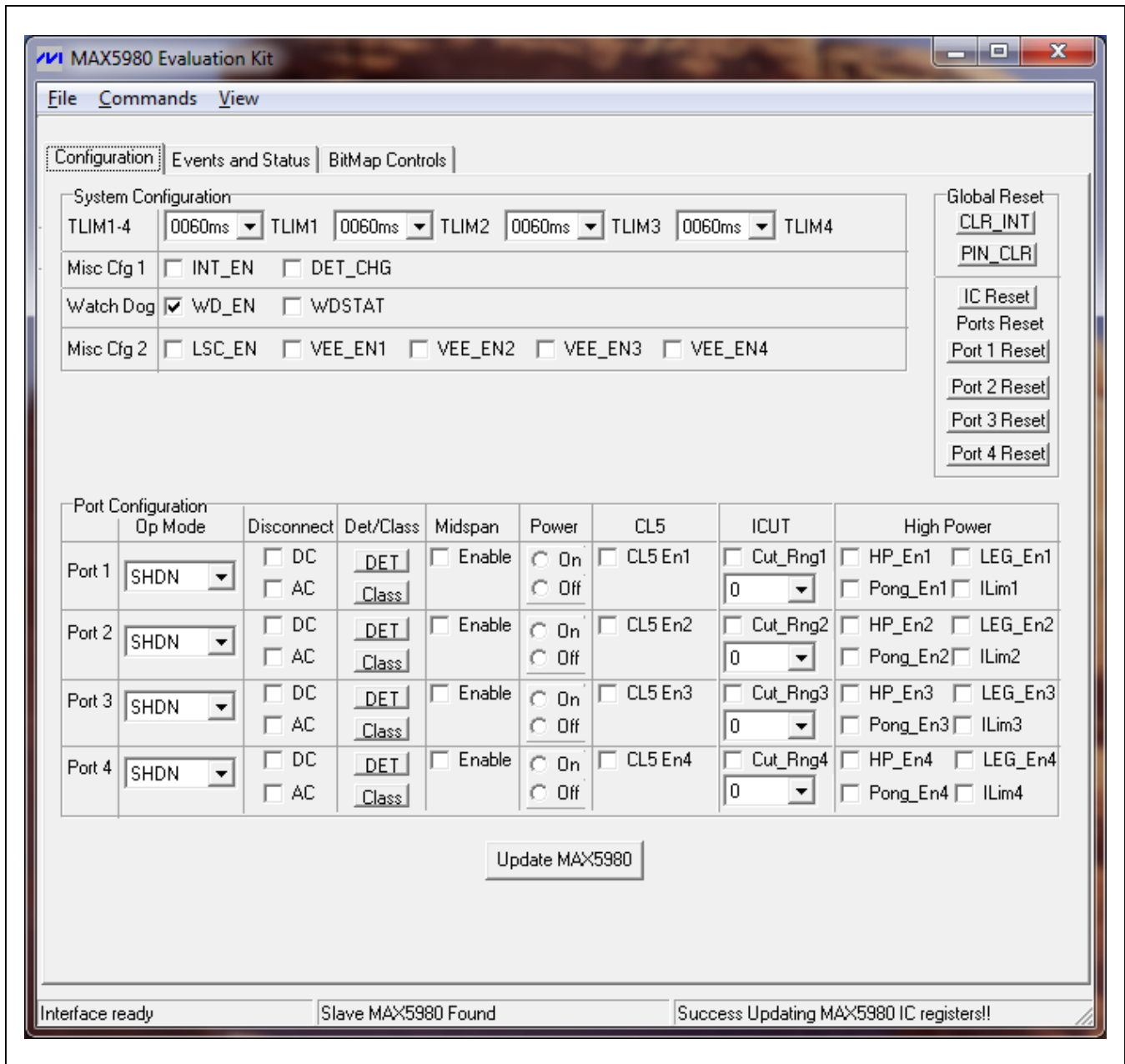

Figure 2. MAX5980 EV Kit Software (Configuration Tab)

MAX5980 Evaluation Kit

Evaluates: MAX5980

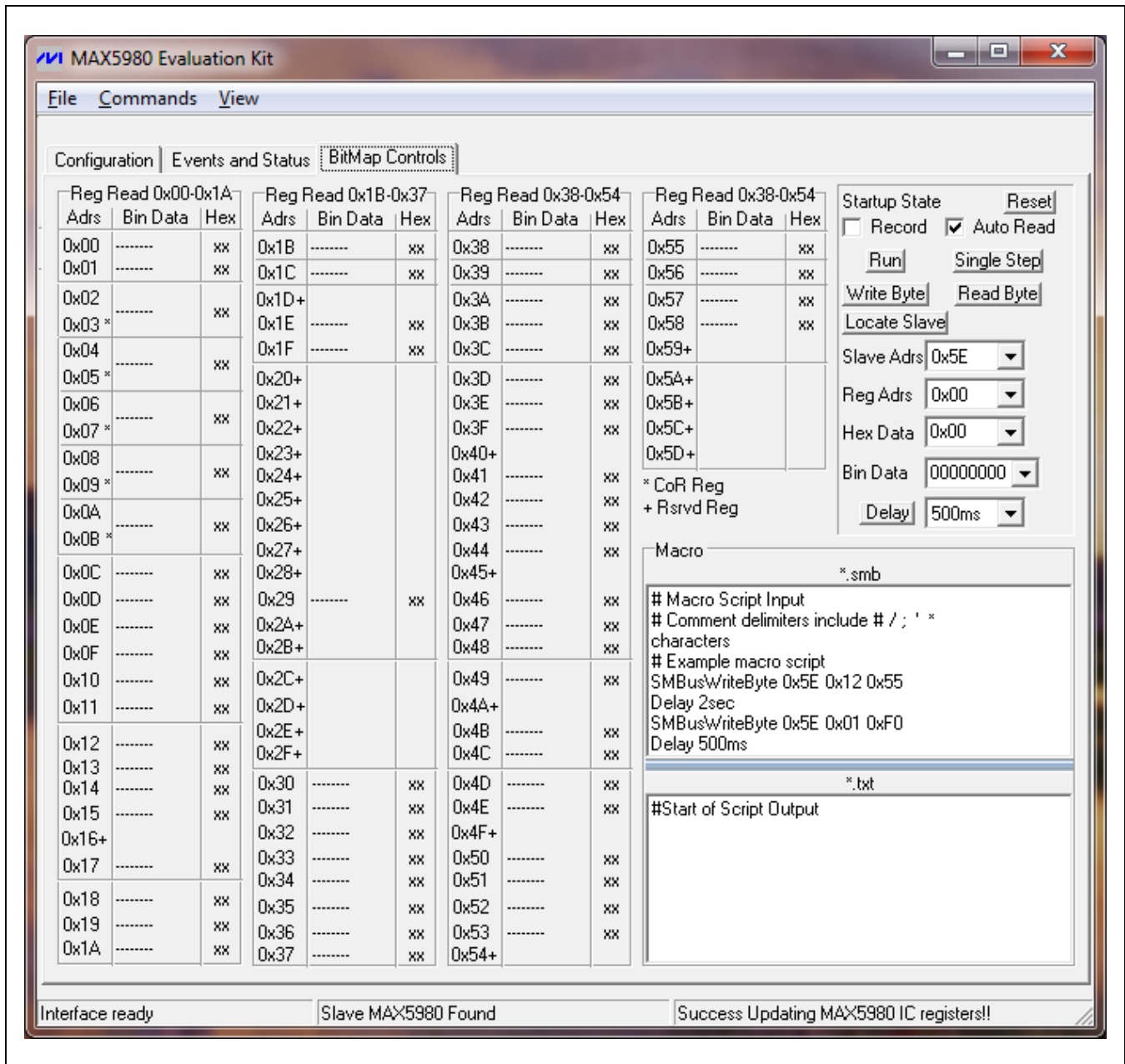

Figure 3. MAX5980 EV Kit Software (BitMap Controls Tab)

MAX5980 Evaluation Kit

Evaluates: MAX5980

Auto Read/Run Macro State Controls

When the **Auto Read** checkbox in the **Startup State** group box is checked, the program continuously updates the main window registers and operates in the auto read state. In the auto read state, data can be written to the IC by entering or selecting the desired data in the **Reg Adrs** and the **Hex Data** or **Bin Data** combo boxes. Pressing the **Write Byte** button writes the combo box data to the IC. To perform an immediate register read, enter or choose the desired register address and press the **Read Byte** button. Hexadecimal or binary data can be entered in the **Hex Data** or **Bin Data** combo boxes and then the alternate combo box displays the corresponding number in the respective number base.

If the **Auto Read** checkbox is unchecked, the program's main window displays register data from the last read. To obtain current data, a **Read Byte** must be performed after selecting the appropriate register address from the **Reg Adrs** combo box. The auto read state does not read the clear-on-read (CoR) register.

A macro can be run after loading the file from the **File | Open Macro** menu item. The opened macro is displayed in the upper half of the **Macro** edit field and has an smb file extension. Pressing the **Run** button runs the macro to completion and the output is displayed in the **Macro Script Output** edit field. Each edit box can be sized relative to the other half using the splitter bar above the **Script Output** text. Pressing the **Single Step** button instead of the **Run** button causes the macro to execute a single line with each press of the **Single Step** button. The **Reset** button is used to reset the macro script engine and clear the **Macro Script Output** edit field. A macro can be run regardless of the **Auto Read** checkbox status. A macro can also be run immediately after opening the software by using the **File | Open/Run Macro** menu item, selecting the desired macro to run, and pressing the **Open** button. Pressing the **Cancel** button exits this feature.

The **Locate Slave** button is used to search for a MAX5980 located on the I²C serial interface whose address has been changed while the software was running. The valid IC slave address range is 0x50 through 0x5F.

Record Macro State Controls

When the **Record** checkbox is checked, the program automatically enters the record macro state and disables certain buttons and menus. Choosing the **Commands | Clear Script Input** menu item clears any script presently in the **Macro** script input edit field. Comment lines in a macro script begin with **# / ; ' *** characters. A line of script is entered by choosing the appropriate **Slave Adrs, Reg**

Adrs, and entering the desired **Hex Data** or **Bin Data** in the combo boxes. Pressing the **Write Byte** or **Read Byte** button enters the script into the **Macro** input edit field. For time delays in a macro, select the desired delay time from the drop-down list on the right side of the **Delay** button and then press the **Delay** button. The macro must be saved before exiting the record macro state using the **File | Save Macro** menu item. The macro file name must have an smb file extension.

To edit a previously saved macro, open the macro using the **File | Open Macro** menu item and make the desired edits. The modified file must be saved prior to exiting the record macro state. Uncheck the **Record** checkbox to exit the record macro state. Additionally, a macro can be created or edited using a plain text editor in "Text Mod." The file must be saved with an smb extension.

General-Purpose Advanced User Interface Utility

There are two methods for communicating with the IC: through the main window display or through the general-purpose advanced user interface utility using the **View | Interface** menu item. This window provides direct, low-level access to the IC through the I²C-compatible 2-wire interface (Figure 4). The utility configures the I²C interface parameters such as the start and stop bits, acknowledgements, and clock timing. The 2-wire interface window allows the user to send general-purpose I²C commands using the **SMBusWriteByte/SMBusReadByte** and **SMBusWriteWord/SMBusReadWord** commands. For more information on the differences between the I²C interface and SMBus interface, read Application Note AN476: *Comparing the I²C Bus to the SMBus*, available at <http://pdfserv.maximintegrated.com/en/an/AN476.pdf>. When using the advanced user interface utility, the main window display no longer keeps track of changes sent to the hardware. The EV kit can be reinitialized to the startup screen settings by first closing the advanced user interface utility and then selecting the **Configuration** tab sheet. Select the **IC Reset** pushbutton and then select the **Events and Status** tab sheet.

The **Hunt for active listeners** button scans the entire 2-wire address space, reporting each address that is acknowledged. The **SMBusWriteByte** command transmits the device address, command, and 1 byte of data. The **SMBusReadByte** transmits the device address, command, and then retransmits the device address and reads 1 byte of data. The **SMBusWriteWord** and **SMBusReadWord** operate the same, except 2 bytes of data are used.

MAX5980 Evaluation Kit

Evaluates: MAX5980

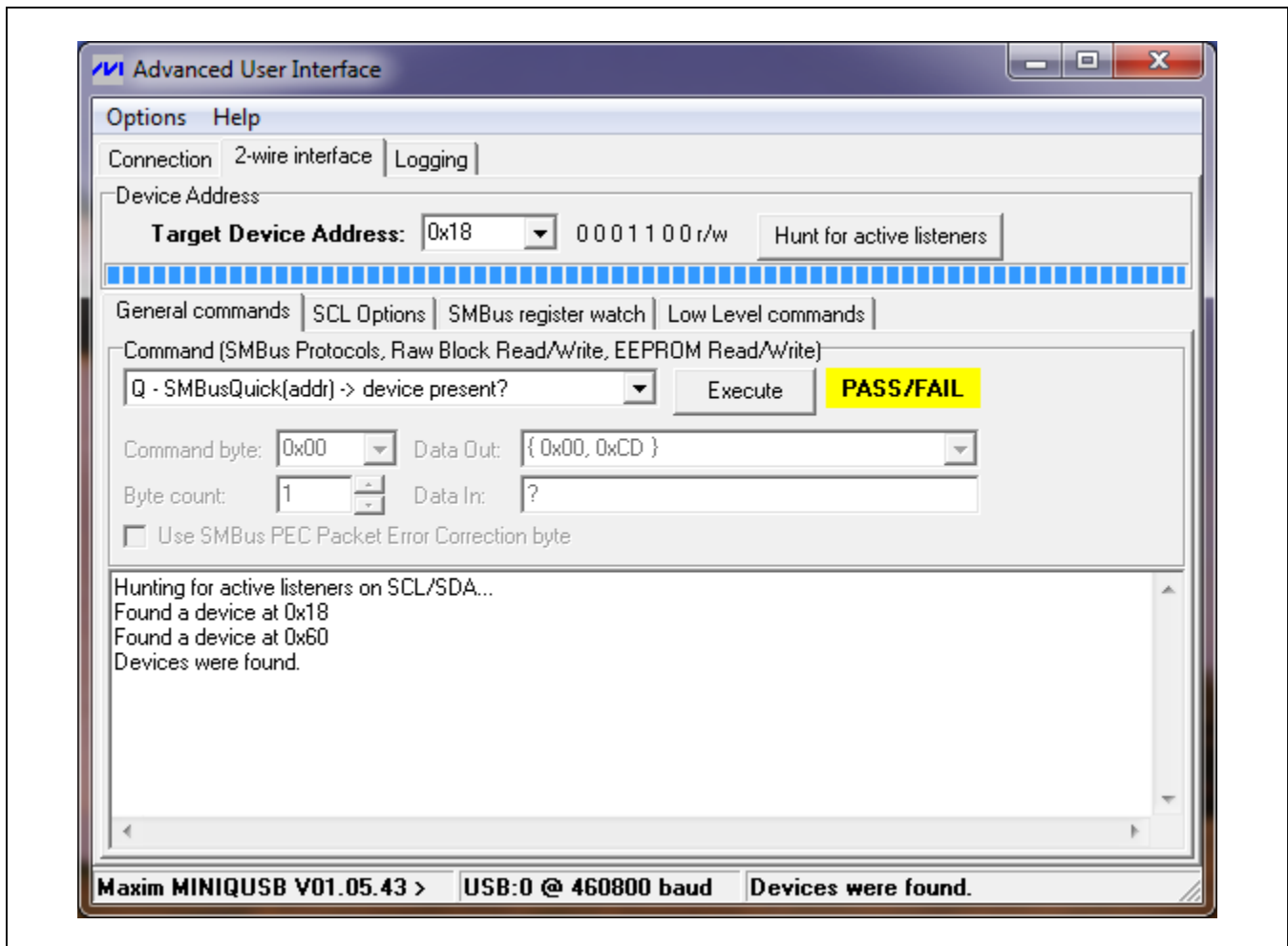

Figure 4. Advanced User Interface (2-Wire Interface)

General Troubleshooting

Problem: Software reports it cannot find the USB interface circuit.

- Is the USB interface circuit power LED D201 lit?
- Is the USB communications cable connected?
- Has Windows plug-and-play detected the board? Bring up **Control Panel System | Device Manager**, and look at what device nodes are indicated for the USB. If there is an unknown device node attached to the USB, delete it—this forces plug-and-play to try again.

Problem: Software reports MAX5980 IC not found, exiting program.

- Are the SCL_IN and SDA signals pulled up to Opto_VCC (3.3V)?
- If using jumper wires to connect could the SCL_IN and SDA signals be swapped? Could the OPTO_GND ground return be missing?

Detailed Description of Hardware

The MAX5980 EV kit features a 10/100/1000BASE-TX Ethernet 4-port PSE controller circuit for -48V/-54V supply rail systems. The EV kit's PSE circuit uses the IEEE 802.3af/at-compliant MAX5980 PSE controller, four n-channel power MOSFETs in 8-pin SO surface-mount packages, eight surface-mount current-sensing resistors, and four 10/100/1000BASE-TX magnetic modules (integrated in J2) to form the basic portion of a PSE circuit. The EV kit has been designed as an IEEE 802.3af/at-compliant PSE and demonstrates all the required functions such as PD discovery, classification, current-limit control of a connected PD at each Ethernet output port, and DC disconnect detection. A PC can be used to communicate with the slave IC over the I²C interface, optically coupled logic, and the 2-wire to USB-port interface circuit.

MAX5980 Evaluation Kit

Evaluates: MAX5980

The EV kit PSE circuit requires a -32 to -60V power supply (-48V/-54V supply rail) capable of supplying 4A to the EV kit's GND and VEE steel banana jacks or PCB pads. A separate +3.3V power supply capable of supplying 100mA is also required for the IC's optically isolated I²C-compatible 2-wire interface if the USB interface circuit is not used. **Note:** The DGND and VEE are shorted by a 0Ω resistor (R19). AGND and GND are shorted by a 0Ω resistor (R68).

The IC controls the -48V/-54V DC power to each of the four 10/100/1000BASE-TX Ethernet output ports by regulating the respective port's n-channel power MOSFET and sensing current through the respective port's current-sense resistors. The current is fed to the 10/100/1000BASE-TX magnetic module connected to the respective Ethernet output port's RJ45 jack. An IEEE 802.3af/at-compliant PD connects to the respective Ethernet output port (J2 upper ports) on the EV kit. The PD can be located up to 350ft from the EV kit when connected with a twisted 4-pair Ethernet cable. The EV kit provides separate and independent power control for each of the four Ethernet output ports. The 10/100/1000BASE-TX magnetic module is internally decoupled from the EV kit's chassis ground. **Note:** The EV kit's isolated chassis ground (Chassis_GND) PCB pad connects to the network system ground.

The EV kit features configurable operational modes, PD detection, PD classification, overcurrent protection, current foldback, under/overvoltage protection, DC disconnect monitoring, high-power mode, and port current information through the I²C interface. The overcurrent protection can be programmed through the software. Each of the four modes of operation (auto, semi, manual, and shutdown) can be evaluated after configuring jumper JU6 and configuring the appropriate IC register (see Table 3), or using the software's high-level **Configuration** tab sheet (see Figure 2). Each port features a 600W bidirectional overvoltage-transient suppressor diode (D9-D12) and decoupling capacitor (C26-C29) for transient protection at the port.

Test points and jumpers have been provided for voltage probing and current measurements of each channel's power circuit. **Note:** When using the header signals, caution should be exercised since the DGND and VEE are shorted by a 0Ω resistor (R19). AGND and GND are shorted by a 0Ω resistor (R68). Additionally, since the GND is more positive than VEE, use an isolated oscilloscope when probing signals with respect to VEE. Green LEDs, relative to each port's RJ45 output jack, indicate when the respective port's power is turned on.

The EV kit provides optical isolation for the I²C-compatible 3-wire interface required by the IC operating as a slave device with optocouplers U7 and U8. The

optically isolated interface connects to a computer's USB port through the USB interface circuit. The EV kit's I²C-compatible 2-wire or 3-wire interface can be reconfigured for interfacing to a stand-alone microcontroller for isolated (2-wire) or nonisolated (3-wire) serial operation. A separate +3.3V power supply capable of supplying 100mA is required for the IC's optically isolated I²C-compatible 2-wire interface. **Note:** The DGND and VEE are shorted by a 0Ω resistor (R19). AGND and GND are shorted by a 0Ω resistor (R68).

The optical isolation consists of optocoupler U7, which provides galvanic isolation for the serial-interface clock line (SCL) and serial-interface input data line (SDAIN) signals. Optocoupler U8 provides galvanic isolation for the serial output and data line (SDAOUT) and $\overline{\text{INT}}$ signals. The 3-wire serial interface SCL and SDAOUT signals are combined on the isolated 2-wire side prior to feeding logic buffer U9. The respective JU9 SCL_IN, SDA, $\overline{\text{INT}}$ _OUT, OPTO_GND, and OPTO_VCC PCB pads are used for 2-wire isolated stand-alone operation. For nonisolated stand-alone 3-wire operation, jumper JU9 shorting traces must be cut open and then the SCL, SDAIN, SDAOUT, $\overline{\text{INT}}$, DGND, and VDIG PCB pads must be connected to the microcontroller circuit. The VDIG is set at +3.3V. The OPTO_GND, GND, and DGND planes are isolated by the optocouplers. **Note:** When using the EV kit in a nonisolated configuration, caution should be exercised since the DGND and VEE are shorted by a 0Ω resistor (R19). AGND and GND are shorted by a 0Ω resistor (R68). Additionally, since the GND is more positive than VEE, use an isolated oscilloscope when probing signals with respect to VEE.

The IC slave address is configured by four jumpers (JU1-JU4) and can be configured from 0x50 through 0x5F hexadecimal serial address. Global address 0x60 is accepted by the IC regardless of the jumper settings. See Table 1 for more information on setting the IC slave address.

Jumper Selection

The EV kit features several jumpers to reconfigure the EV kit for various PSE configurations and PD requirements. Additionally, jumpers and PCB pads are provided for connecting an external microcontroller.

I²C-Compatible 2-Wire/3-Wire Slave Address Selection

The EV kit features several 3-pin jumpers (JU1-JU4) to set the slave address of the IC's least-significant bits (LSBs) of the slave address on the I²C-compatible 2-wire or 3-wire interface. The three most-significant bits (MSBs) are set by the IC to 010. The EV kit's software automatically sets the LSB for the proper read/write command. Table 1 lists the jumper address options.

MAX5980 Evaluation Kit

Evaluates: MAX5980

Table 1. Slave Address Selections (JU1–JU4)

SHUNT POSITION				IC SLAVE ADDRESS	READ/WRITE
JU4 (BIT A3)	JU3 (BIT A2)	JU2 (BIT A1)	JU1 (BIT A0)		
2-3	2-3	2-3	2-3	0x40	Read
				0x41	Write
2-3	2-3	2-3	1-2	0x42	Read
				0x43	Write
2-3	2-3	1-2	2-3	0x44	Read
				0x45	Write
2-3	2-3	1-2	1-2	0x46	Read
				0x47	Write
2-3	1-2	2-3	2-3	0x48	Read
				0x49	Write
2-3	1-2	2-3	1-2	0x4A	Read
				0x4B	Write
2-3	1-2	1-2	2-3	0x4C	Read
				0x4D	Write
2-3	1-2	1-2	1-2	0x4E	Read
				0x4F	Write
1-2	2-3	2-3	2-3	0x50	Read
				0x51	Write
1-2	2-3	2-3	1-2	0x52	Read
				0x53	Write
1-2	2-3	1-2	2-3	0x54	Read
				0x55	Write
1-2	2-3	1-2	1-2	0x56	Read
				0x57	Write
1-2	1-2	2-3	2-3	0x58	Read
				0x59	Write
1-2	1-2	2-3	1-2	0x5A	Read
				0x5B	Write
1-2	1-2	1-2	2-3	0x5C	Read
				0x5D	Write
1-2	1-2	1-2	1-2	0x5E	Read
				0x5F	Write
X	X	X	X	0x60*	Read
				0x61*	Write

X = Don't care.

*Global address call.

MAX5980 Evaluation Kit

Evaluates: MAX5980

Mode Selection (Midspan or Signal)

The EV kit features a 3-pin jumper (JU5) to set the IC in midspan or signal mode. Table 2 lists the jumper options for the two modes used to detect a valid PD connected to the PSE's respective Ethernet output port. Refer to the MAX5980 IC data sheet for more information on these modes.

Operational Modes (Automatic and Shutdown)

The EV kit features a 3-pin jumper (JU6) to set the IC's initial startup operational mode. After startup, data sent to the Operating Mode register (R12h) reconfigures the operational mode of the IC. Table 3 lists the jumper options.

Class 5 Enable (EN_CL5)

The EV kit features a 2-pin jumper (JU8) to enable/disable the IC's hardware Class 5 classification settings. Refer to the MAX5980 IC data sheet for Class 5 register settings with respect to this pin. Table 4 lists the jumper options.

Stand-Alone Microcontroller Interface (Isolated/Nonisolated)

The EV kit features PCB pads and a jumper to interface directly with a microcontroller. The 10-pin (2 x 5) jumper (JU9) has shorting connections on the bottom layer that must be cut open to disable the optocoupler interface for nonisolated evaluation. The JU9 jumper shorting connections must be in place for evaluating an isolated stand-alone microcontroller interface or the on-board USB interface circuit. For evaluating an isolated stand-alone microcontroller interface, cut open the PCB trace shorts on jumpers JU10, JU39, and JU40 to isolate the on-board USB interface circuit. Table 5 lists the selectable jumper options.

PORT OUT_, GATE_ Pins Signal Measurements

The EV kit features jumpers to facilitate current and voltage measuring at each port's respective OUT_ and GATE_ pins on the IC. Several 2-pin and 4-pin jumpers are used to obtain the desired measurement for each port. Jumper JU11 is provided for port 1, jumper JU12 is provided for port 2, jumper JU13 is provided for port 3, and jumper JU14 is provided for port 4. The jumper pins are shorted by a PCB trace on the top layer of the EV kit by default for normal operation. The shorts can be cut open for measurements. See Figure 5a for a specific port's jumper.

SENSE_ Pins Signal Measurements

The EV kit features jumpers to facilitate current and voltage measuring at each port's respective SENSE_ pins on the IC. Several 2-pin jumpers are used to obtain the desired measurement for each port. Jumper JU23 is provided for port 1, jumper JU24 is provided for port 2, jumper JU25 is provided for port 3, and jumper JU26 is provided for port 4. The jumper pins are shorted by a PCB trace on the top layer of the EV kit by default for normal operation. The shorts can be cut open for measurements. See Figure 5a for a specific port's jumper.

-48V/-54V Port Power Interface, Voltage Measurement, or Port1/Port3 60W 2 x 2 Pair Operation

The EV kit includes jumpers JU27–JU30 to disconnect each port's -48V/-54V power independently for connection to an external network interface circuit, or to increase the available power at port 1 and/or port 3 up to 60W. Additionally, the respective jumper pins can also be utilized to measure the voltage or current for the respective port. Table 6 lists the specific jumper for each port. Each jumper has a shorted PCB trace on the bottom layer of the PCB.

Table 2. Jumper JU5 Functions

SHUNT POSITION	MIDSPAN PIN	MODE
1-2	Connected to VDIG through resistor R14	Midspan
2-3	Connected to DGND through resistor R14	Signal

Table 3. Initial Startup Operational Mode (JU6)

SHUNT POSITION	AUTO PIN	OPERATING MODE REGISTER (R12h) STATUS BITS	OPERATION MODE
1-2	Connected to VDIG through resistor R15	0x00	Automatic
2-3	Connected to DGND through resistor R15	0xFF	Shutdown

Table 4. Class 5 Enable (JU8)

SHUNT POSITION	EN_CL5 PIN	CLASS 5
Installed	Connected to VDIG	Enabled
Not installed	Connected to DGND internally	Disabled

MAX5980 Evaluation Kit

Evaluates: MAX5980

Table 5. Jumper JU9 and Microcontroller PCB Pad Functions

SHUNT POSITION	ISOLATION MODE	EV KIT PCB PAD TO MICROCONTROLLER CONNECTION
1-2 (Shorted*)	Isolated	OPTO_VCC PCB pad connects to the microcontroller's +3.3V power supply.
3-4 (Shorted*)	Isolated	OPTO_SCL_IN PCB pad connects to the microcontroller's serial-clock line.
5-6 (Shorted*)	Isolated	OPTO_SDA PCB pad connects to the microcontroller's SDA data line.
7-8 (Shorted*)	Isolated	OPTO_SDA PCB pad connects to the microcontroller's SDA data line.
9-10 (Shorted*)	Isolated	$\overline{\text{INT}}_{\text{OUT}}$ PCB pad connects to the microcontroller's $\overline{\text{INT}}$ pin.
—	Isolated	OPTO_GND PCB pad connects to the microcontroller's power-supply ground.
1-2 (Cut open)	Nonisolated	JU9-2 VDIG pin supplies power to the microcontroller from the VDIG voltage.
3-4 (Cut open)	Nonisolated	JU9-4 SCL pin connects to the microcontroller's serial-clock line.
5-6 (Cut open)	Nonisolated	JU9-6 SDAIN pin connects to the microcontroller's SDA data line.
7-8 (Cut open)	Nonisolated	JU9-8 SDAOUT pin connects to the microcontroller's SDA data line.
9-10 (Cut open)	Nonisolated	JU9-10 $\overline{\text{INT}}$ pin connects to the microcontroller's $\overline{\text{INT}}$ pin.
—	Nonisolated	TP DGND connects to the microcontroller's power-supply ground.

*Default set by PCB trace.

Table 6. -48V/-54V Port Power Interface Jumper Functions

PORT	JUMPER	PCB TRACE SHORT	EV KIT OPERATION
Port 1	JU27	Trace shorted at pins 1-2	Normal operation (30W) or (60W)
		Cut open	-48V_1 power available at pin 1 only
	JU31	Open	Normal operation (30W)
Port 2	JU28	Trace shorted at pins 1-2	Normal operation (30W)
		Cut open	GND* power not available at pin 1
	JU32	Trace shorted at pins 1-2	Normal operation (30W)
		Cut open	-48V_2 power available at pin 2 only
		Cut open and install short at pins 2-3	-48V_2 power feeds to port 1 (60W)*
Port 3	JU29	Trace shorted at pins 1-2	Normal operation (30W or 60W)
		Cut open	-48V_3 power available at pin 1 only
	JU33	Open	Normal operation (30W)
Port 4	JU30	Trace shorted at pins 1-2	GND feeds to port 3 (60W)*
		Trace shorted at pins 1-2	Normal operation (30W)
		Cut open	-48V_4 power available at pin 2 only
	JU34	Cut open and install short at pins 2-3	-48V_4 power feeds to port 3 (60W)*
		Trace shorted at pins 1-2	Normal operation (30W)
		Cut open	-48V_4 power available at pin 2 only*

*Port 1/port 3 60W operation.

MAX5980 Evaluation Kit

Evaluates: MAX5980

EN Signal

The EV kit features a pushbutton switch (S1) to enable or disable the IC.

Ethernet Optional PHY-Side Ethernet Connections

The EV kit includes jumpers JU35–JU38 for a user to use the optional PHY-side Ethernet connections (GND_P1, GND_P2, GND_P3, and GND_P4; VCC_P1, VCC_P2, VCC_P3, and VCC_P4). PCB pads are provided for connecting an external VCC power supply. See J2 in the *Component List* for specific connections. Table 7 lists the specific jumper for each port. Jumpers JU32 and JU34 have a shorted PCB trace on the bottom layer of the PCB.

External +3.3V VDIG Operation

The EV kit's on-board +3.3V LDO circuit can be reconfigured to operate the EV kit circuit with an externally supplied +3.3V DC source. Follow the step below to operate the EV kit with an externally supplied +3.3V source:

- Remove resistor R16, isolates the on-board LDO, U10.
- Connect the external +3.3V power-supply ground terminal to the VEE PCB pad and the external power-supply positive to the VDIG PCB pad.
- Remove resistor R55.

Table 7. PHY-Side Ethernet Connections Jumper Functions (JU35–JU38)

PORT	JUMPER	PCB TRACE SHORT	EV KIT OPERATION
Port 1	JU35	Open	Isolate PHY and PoE
		Install short	PHY and PoE share the same GND
Port 2	JU36	Open	Isolate PHY and PoE
		Install short	PHY and PoE share the same GND
Port 3	JU37	Shorting trace intact	Isolate PHY and PoE
		Cut open	PHY and PoE share the same GND
Port 4	JU38	Open	Isolate PHY and PoE
		Install short	PHY and PoE share the same GND

MAX5980 Evaluation Kit

Evaluates: MAX5980

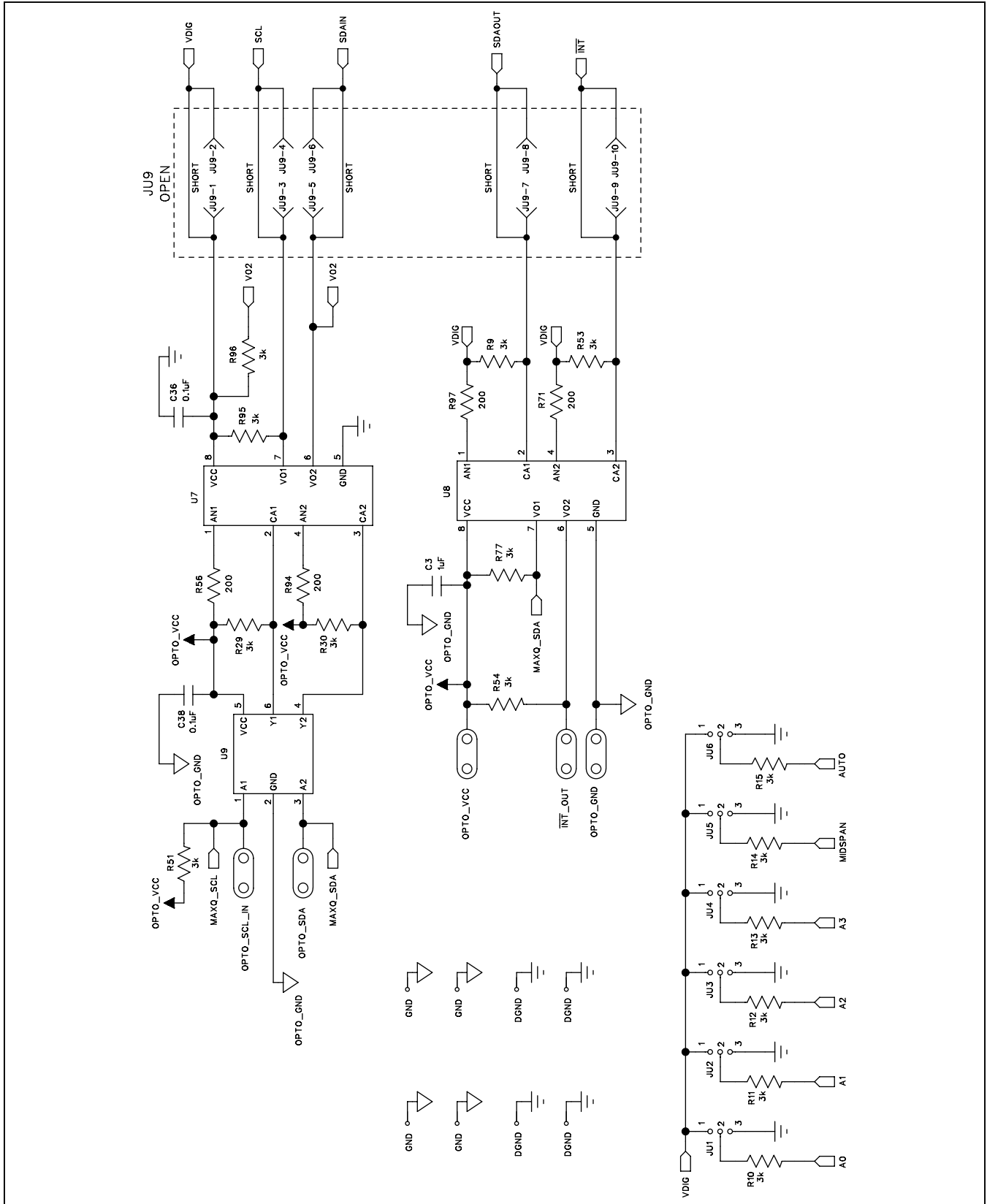

Figure 5b. MAX5980 EV Kit Schematic (Optocoupler Circuit)

MAX5980 Evaluation Kit

Evaluates: MAX5980

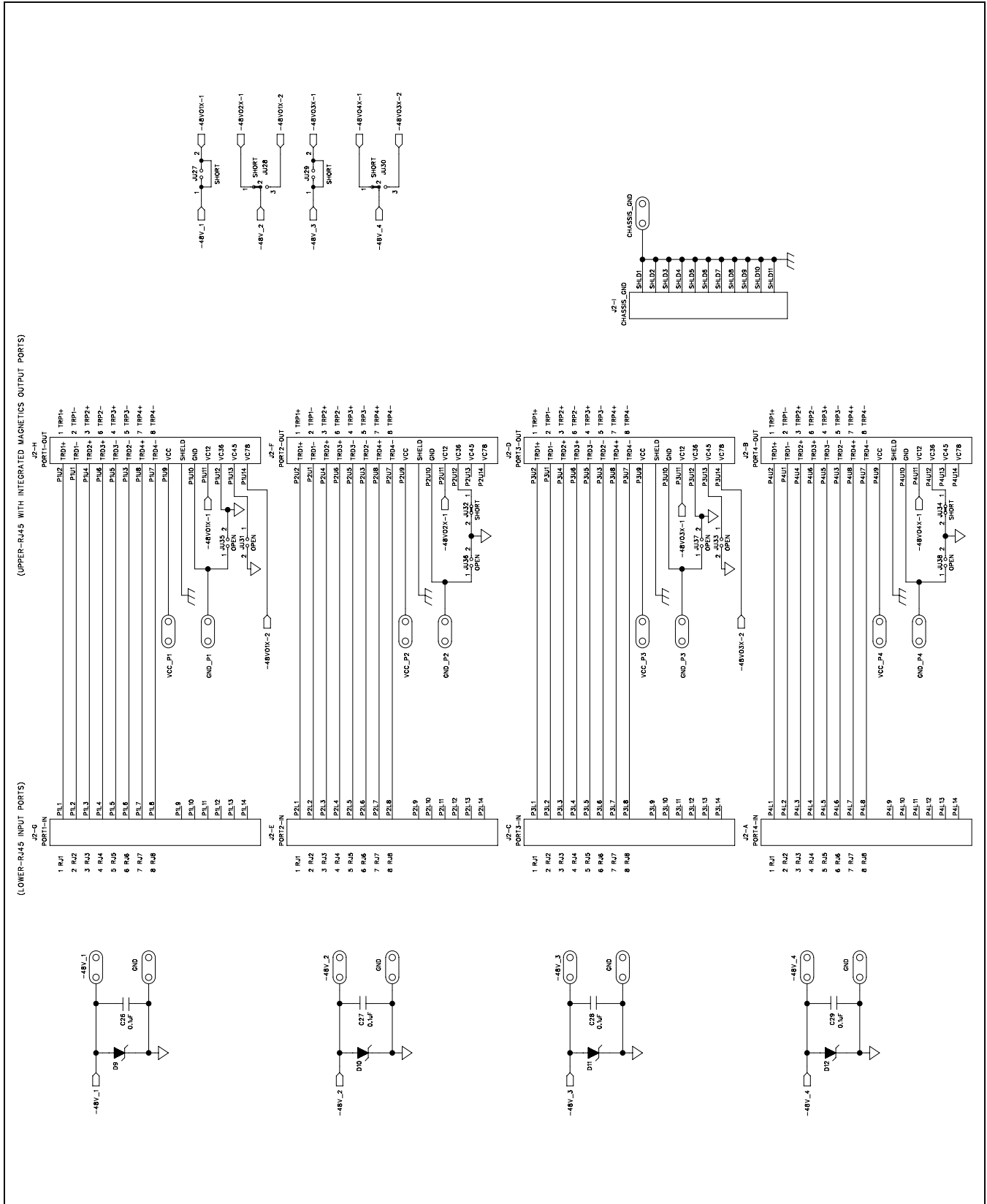

Figure 5c. MAX5980 EV Kit Schematic (Ethernet Network Interface)

MAX5980 Evaluation Kit

Evaluates: MAX5980

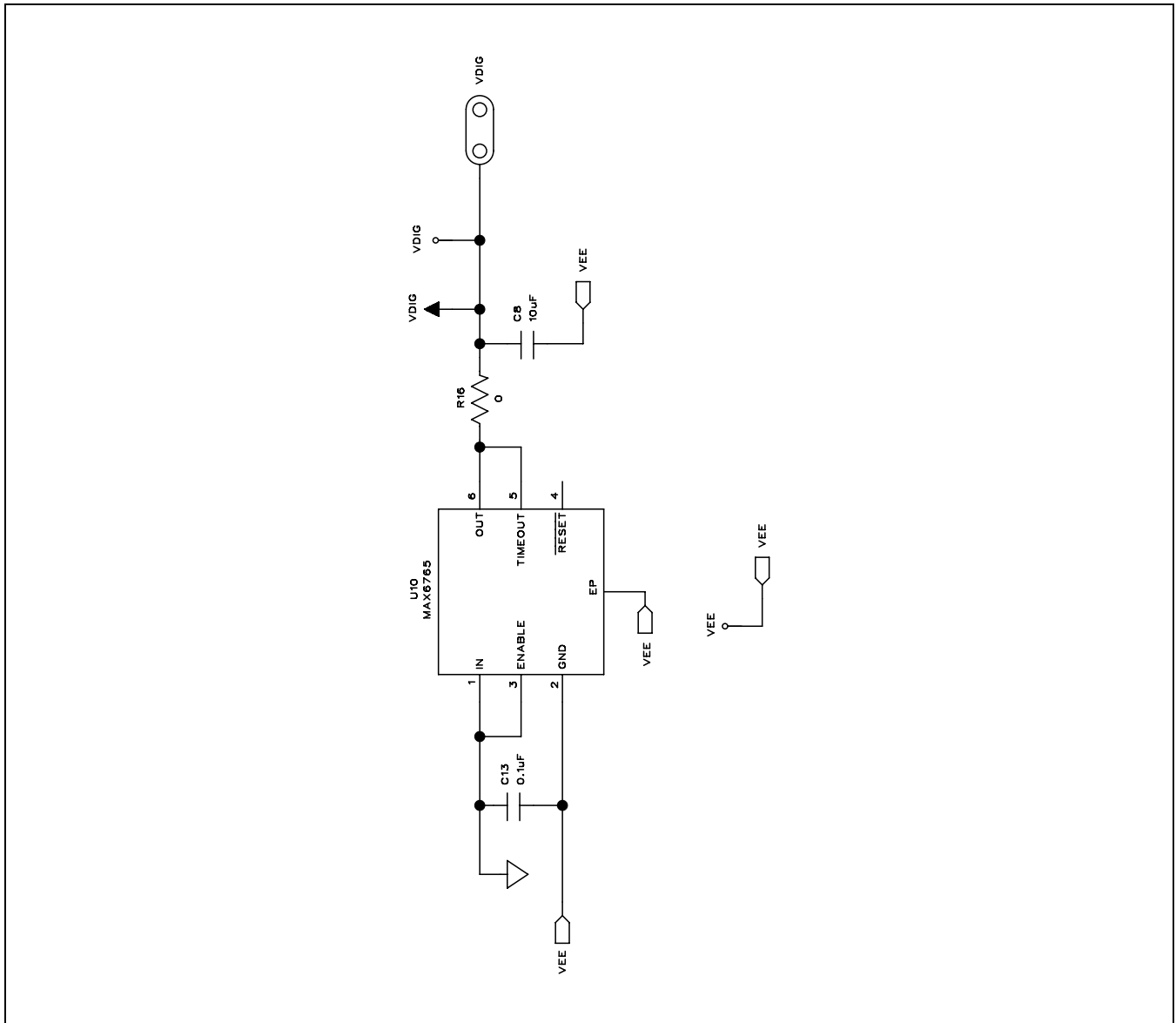
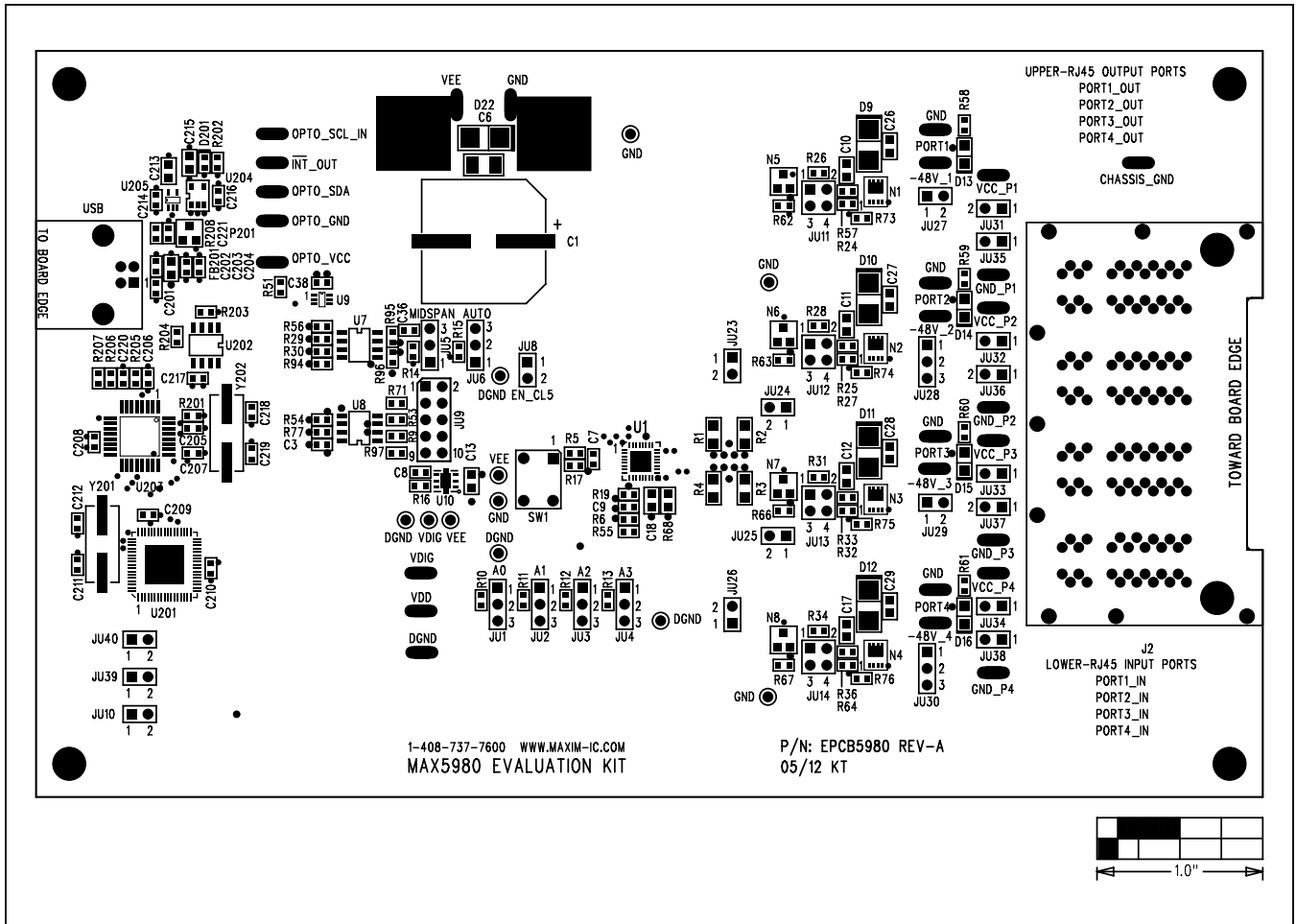

Figure 5d. MAX5980 EV Kit Schematic (3.3V Power-Supply Circuit)

MAX5980 Evaluation Kit

Evaluates: MAX5980



MAX5980 Evaluation Kit

Evaluates: MAX5980

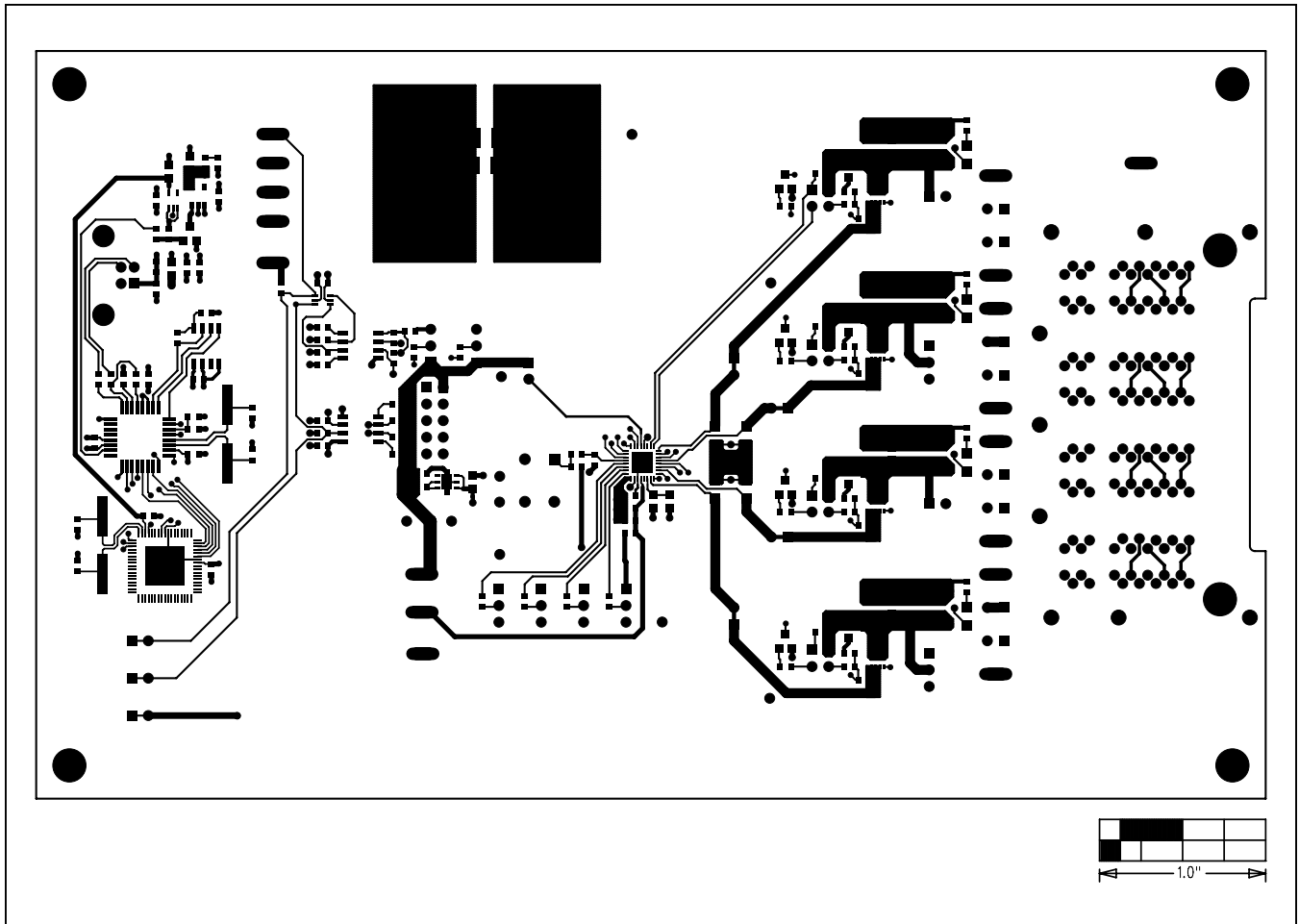

Figure 7. MAX5980 EV Kit PCB Layout—Component Side

MAX5980 Evaluation Kit

Evaluates: MAX5980

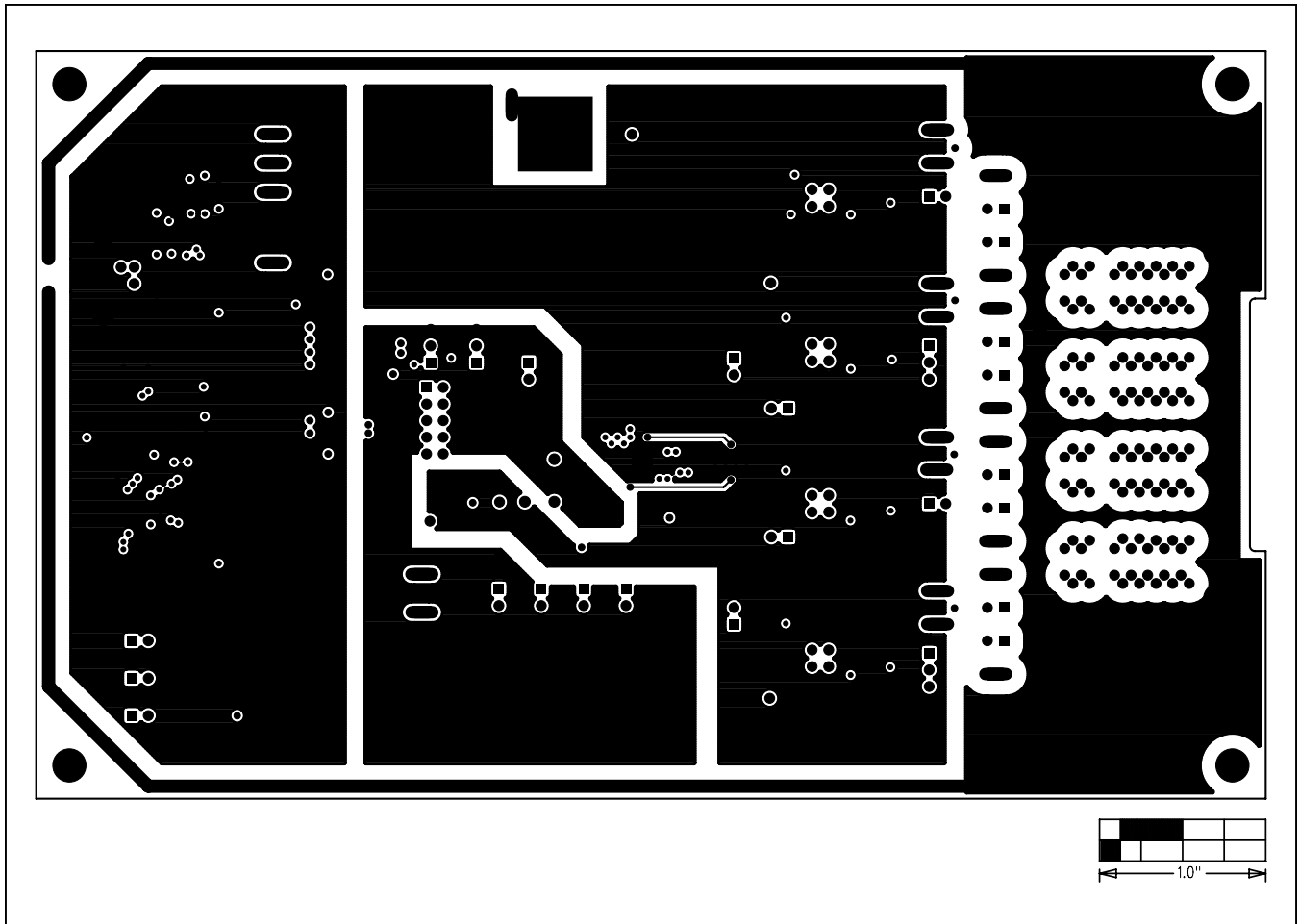

Figure 8. MAX5980 EV Kit PCB Layout—VEE/DGND/CHGND/OPTO_GND Layer 2

MAX5980 Evaluation Kit

Evaluates: MAX5980

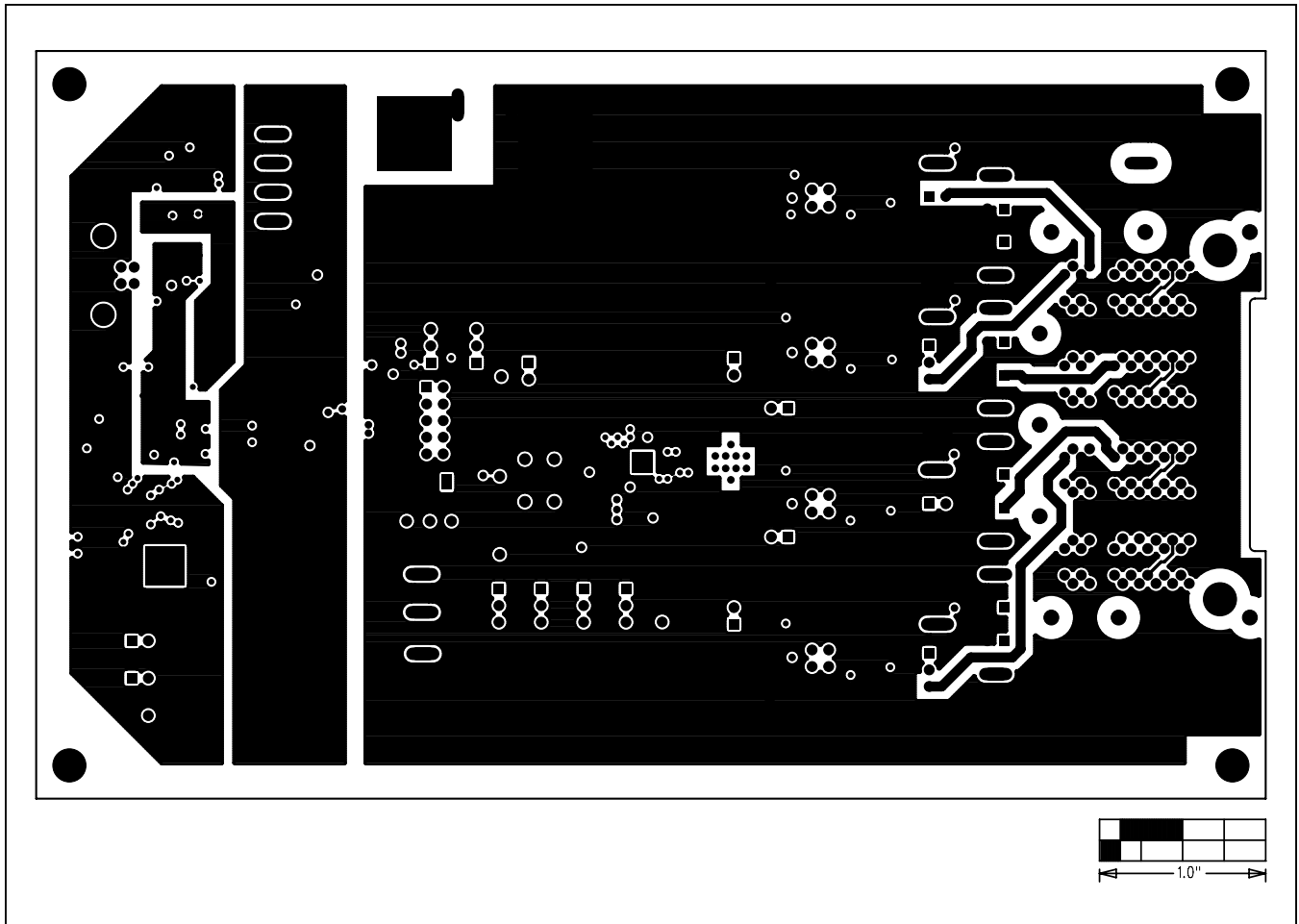

Figure 9. MAX5980 EV Kit PCB Layout—GND/OPTO_VCC/+3.3V/+5V/VBUS Layer 3

MAX5980 Evaluation Kit

Evaluates: MAX5980

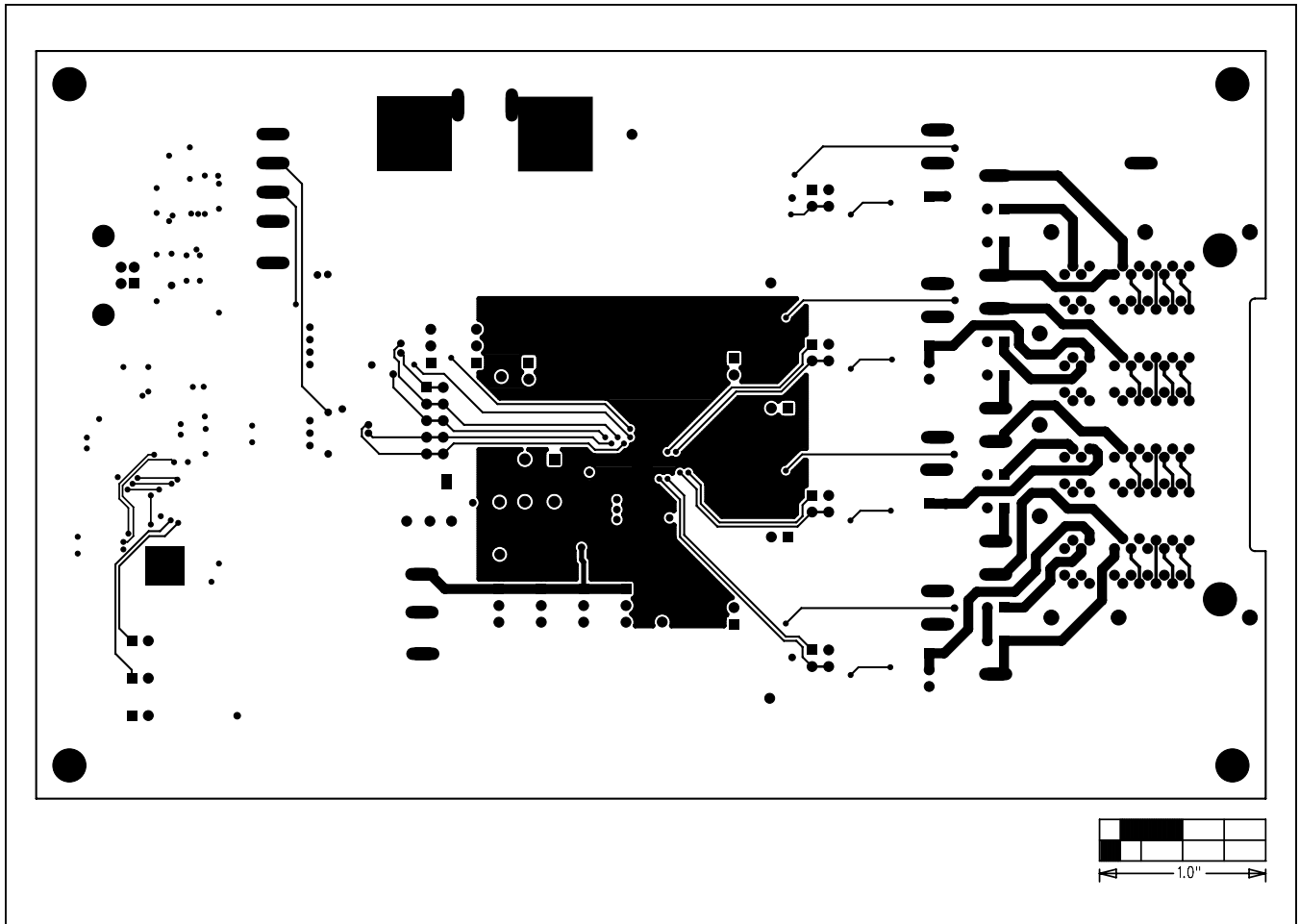

Figure 10. MAX5980 EV Kit PCB Layout—Solder Side

MAX5980 Evaluation Kit

Evaluates: MAX5980

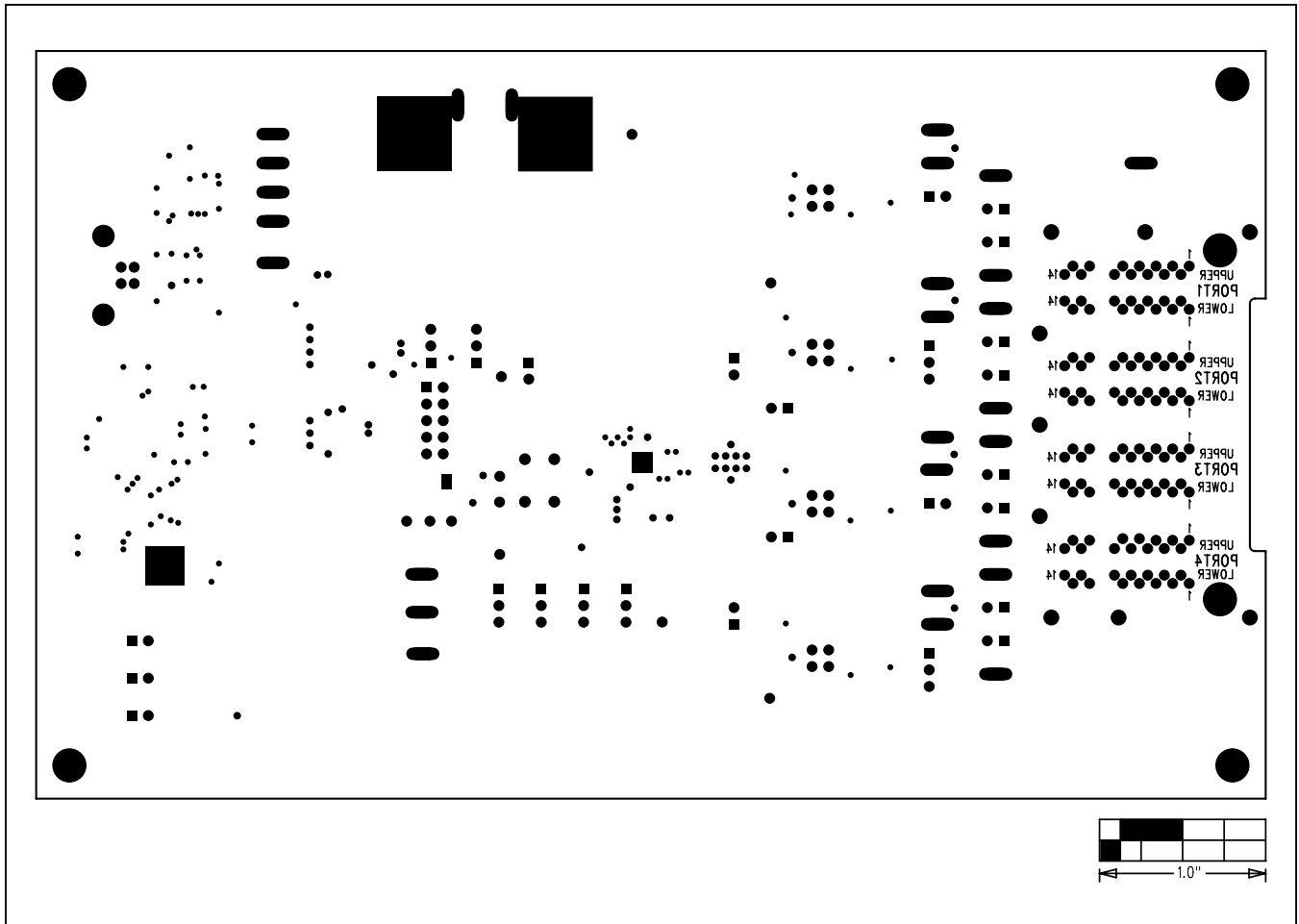

Figure 11. MAX5980 EV Kit Component Placement Guide—Solder Side

MAX5980 Evaluation Kit

Evaluates: MAX5980

Ordering Information

PART	TYPE
MAX5980EVKIT#	EV KIT

#Denotes RoHS compliant.

MAX5980 Evaluation Kit

Evaluates: MAX5980

Revision History

REVISION NUMBER	REVISION DATE	DESCRIPTION	PAGES CHANGED
0	8/12	Initial release	—



Maxim Integrated cannot assume responsibility for use of any circuitry other than circuitry entirely embodied in a Maxim Integrated product. No circuit patent licenses are implied. Maxim Integrated reserves the right to change the circuitry and specifications without notice at any time.

Maxim Integrated 160 Rio Robles, San Jose, CA 95134 USA 1-408-601-1000

28